



PERIMETER PROTECTION SYSTEMS

NEW. Flat-foundation bollard M50, fixed High Security Line bollard ST

HÖRMANN





4

Good reasons
to opt for Hörmann's
perimeter protection
systems.



18

Application
areas.



28

Versions.
Accessories.
Technology.

Hörmann brand quality



The family-owned company Hörmann offers all important construction components for building and renovating projects from a single source. We manufacture in highly specialised factories using state-of-the-art production technologies. Our employees work intensively on new products, continual further developments and improvements to details. The results are patents and unique products on the market.





AN EYE ON THE FUTURE. Hörmann is setting a good example. That's why 100% of our electricity needs in Germany come from green electricity. Together with an intelligent and certified energy management system, CO₂-neutral mailing and the recycling of valuable materials, more than 40000 tons of CO₂ are saved each year. In addition, we offset over 100000 tonnes of CO₂ by promoting wind energy and reforestation projects in cooperation with ClimatePartner.



Sustainable planning and competent advice

Experienced specialists within our customer-oriented sales organisation accompany you from the planning stage, through technical clarification up to the final building inspection. Complete working documentation, such as, e.g. technical manuals, are always accessible and up-to-date at www.hormann.co.uk.



A STRONG PARTNER FOR PERIMETER PROTECTION

SYSTEMS. At Hörmann, innovation is produced in-house – highly qualified employees of the development departments are in charge of product optimisation and new developments. This results in market-ready, high-quality products that are very popular around the globe. All major system components are developed and manufactured by Hörmann, guaranteeing high compatibility, full functionality and optimal safety. Our wide range of bollards for different applications, road blockers, tyre killers and complete control concepts makes us a strong partner for security solutions.



ARCHITECTS' PROGRAM. Clearly structured navigation via drop-down menus and symbols, as well as a search function, provide faster access to texts for invitations to tenders and more than 9000 drawings (in DWG and PDF format) of over 800 Hörmann products in Germany (offer varies by country). In addition, BIM data can be provided for many products for the Building Information Modelling process, enabling efficient planning, drafting, construction and management of buildings. Photos and photo-realistic presentations provide additional information on many products.



Plan with the Architects' Program at
<https://architektenprogramm.hoermann.de>

Easy to fit and service

All functional components of our bollards are fitted in an assembly-friendly way and enable a very quick and easy initial start-up. In addition, the new generation of perimeter protection systems can also be integrated into digital service and remote maintenance concepts. This lowers the maintenance and service costs, making Hörmann perimeter protection systems economical and sustainable.





**Round-the-clock
service**

FAST SERVICE. We recommend a semi-annual maintenance cycle for our perimeter protection systems. Hörmann offers consulting, maintenance and repairs in many countries. Our extensive service network means that we are always nearby and at your service around the clock. Our customers can rely on us.



**10-year guaranteed
availability**

HÖRMANN SPARE PARTS. It goes without saying that spare parts for all our components are original Hörmann parts that come with a 10-year guaranteed availability.



High Security bollard with brushless
electromechanical operator

ENVIRONMENTALLY-FRIENDLY AND FLEXIBLY FITTED.

For bollards with an integrated hydraulic operator, all the functional components are installed in the bollard unit. The integrated hydraulic system requires only a small amount of oil, reducing the environmental risk significantly. As standard, we use biodegradable oil to rule out environmental risks completely. Security and High Security bollards with integrated electro-mechanical operator are particularly environmentally-friendly and low maintenance. Because they do not require hydraulic oil, they also meet strict environmental regulations.

Another advantage of both versions: The control can be fitted up to 80 metres away from hydraulic bollards or 50 metres away from electromechanical bollards using a power / connection cable.

Secure technology and attractive design

Our extensive range of bollards includes automatic, semi-automatic, fixed and removable versions (see pages 21 and 22) for security and traffic control in inner-city areas, public spaces and company premises. The intelligent designs combine an attractive appearance with secure technology.





Automatic bollard
A 220-600 H



Semi-automatic bollard
S 220-600 G



Fixed bollard
F 220-600 CF



Matching appearance

MATCHING BOLLARD VERSIONS. The cylinders of all bollards in the individual systems have a matching appearance, allowing for a customised combination of Security and High Security Line bollards. In addition, fixed, semi-automatic and automatic bollards can be combined perfectly thanks to the bottom plate with a matching appearance. The result is a harmonious overall look.



SECURITY FAST IN CASE OF EMERGENCY. An open driveway does not have to pose a security threat. Thanks to the EFO emergency function (Emergency Fast Operation), the lowered bollards and road blockers as well as tyre killers are extended very quickly, in just about 1.5 seconds, offering security fast in emergency situations.

Individual control concepts

Complete control concepts, e.g. comprising multiple bollards, can be operated using a flexible control. The concept also allows master and slave relationships to be configured between the bollards.





SIMPLE FITTING AND MAINTENANCE. The control is connected via service-friendly quick-connect terminals. These simplify fitting and make subsequent maintenance easier. The control can also be extended with control elements (such as code switches) and / or other activating kits, e.g. for induction loops.

SOPHISTICATED SECURITY. The perimeter protection systems can also be conveniently operated using the BiSecur radio system. The extremely secure BiSecur encryption protocol, developed by Hörmann, makes sure that no one can copy your radio signal.

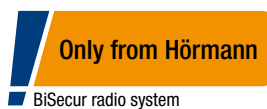

→ For further information, see page 64.

NEW. HÖRMANN ACCESS CONTROL (HAC). Using Hörmann Access Control (HAC), our proprietary online management system developed in-house, bollards can be conveniently and safely operated and managed remotely to control entry and exit. The flexible solution allows individual access authorisation and optional assignment of up to 2000 ID card media.

→ For further information, see from page 62.

Maximum security and function

The security provided by a bollard is measured based on different impact energies. The energy caused by a colliding vehicle depends on the vehicle type, weight and speed. The impact energy is crucial when it comes to damage and the function of the bollards.





Real crash tests with high loads allow us to optimally prepare our innovations for the official inspections by the authorised test centres for official approvals. In this test, a 7.5 tonne lorry (remote-controlled) crashes into a road blocker at a speed of 80 km/h, for example. The various certifications from the USA and Europe are equally recognised internationally if they meet the same requirements.



American Certification DOS SD-SDT – 02.01
 Performed at Texas Transportation Institute
 The Texas A&M University System,
 Texas U.S.A.

Crash Test – K12 Rating

Vehicle weight: 6.8 t
 Speed: 80 km/h
 Impact energy: 1679012 joules (J)

Crash Test – K4 Rating

Vehicle weight: 6.8 t
 Speed: 50 km/h
 Impact energy: 655864 joules (J)



Certification ASTM F2656-07
 Performed at Karco Engineering, LLC.
 Automotive Research Center, Adelanto CA,
 U.S.A.

Crash test – M50 rating

Vehicle weight: 6.8 t
 Speed: 80 km/h
 Impact energy: 1679012 joules (J)

Crash test – M30 rating

Vehicle weight: 6.8 t
 Speed: 50 km/h
 Impact energy: 655864 joules (J)



Certification PAS68:2013

Performed at Aisico srl
 Crash Test Center, Pereto (Aq) – Italy

Crash test – rating PAS68:2013

Vehicle weight: 7.5 t
 Speed: 80 km/h
 Impact energy: 1851852 joules (J)

Crash test – rating PAS68:2013

Vehicle weight: 7.5 t
 Speed: 50 km/h
 Impact energy: 723380 joules (J)



Certification IWA14-1:2013
 Performed at Aisico srl
 Crash Test Center, Pereto (Aq) – Italy

Crash test – rating IWA14-1:2013

Vehicle weight: 7.2 t
 Speed: 50 km/h
 Impact energy: 694444 joules (J)

Crash test – rating IWA14-1:2013

Vehicle weight: 7.2 t
 Speed: 80 km/h
 Impact energy: 1777778 joules (J)

Previous US testing method	Current US testing method	Current testing method Great Britain	Current international testing methods
K4	M30	PAS68	IWA14
K12	M50	PAS68	IWA14

Comparison of the certificates from the USA, Great Britain and international certificates

Quality and security testing

New and further developments in the Security Line and High Security Line are tested in both internal and external tests, examining their resistance to collisions with different loads, as well as their function depending on temperature and weather.



CLIMATIC TESTING. Functional safety is ensured in various climatic conditions through special climatic tests. Different temperatures (from -40°C to $+70^{\circ}\text{C}$), weather conditions and humidities are simulated in climatic test chambers. These tests have high demands and guarantee the reliable function and long service life of our perimeter protection systems.

PENDULUM IMPACT TESTING. The impact resistance of Security Line bollards is examined in special pendulum impact tests. a steel ball on a pendulum simulates the loads resulting during an impact with different speeds and vehicle types. The impact height is also tested individually. This allows us to ensure and even improve upon the high safety of our bollards.

UNCOMPROMISING FUNCTIONAL SAFETY. All perimeter protection systems are tested to ensure full functionality before delivery. All fine mechanical and hydraulic adjustments and the electric and control settings of each individual system component are tested. For systems with multiple components, the compatibility of all interfaces and functions is ensured. With this process, we can guarantee the fastest fitting possible as well as reliable operation of our perimeter protection systems.

The values in the diagram below indicate at which speed and which vehicle weight a certain impact energy is generated.

Impact energy with destruction

The passage of the vehicle is prevented, but the crash causes permanent damage to the mechanics and construction of the bollard. The bollard must be replaced.

Impact energy without destruction

The passage of the vehicle is prevented and the function and safety of the bollard are still guaranteed.

Vehicle types

- Small vehicles with a total weight of up to 800 kg
- Passenger cars with a weight of up to 1200 kg
- Vans with a weight of up to 1900 kg
- Lorries with a weight over 1900 kg

Impact energy with destruction*
 ■ 150000 joules (J)

Impact energy without destruction*
 ■ 40000 joules (J)

*using the example of bollard F 220-600/800 CF

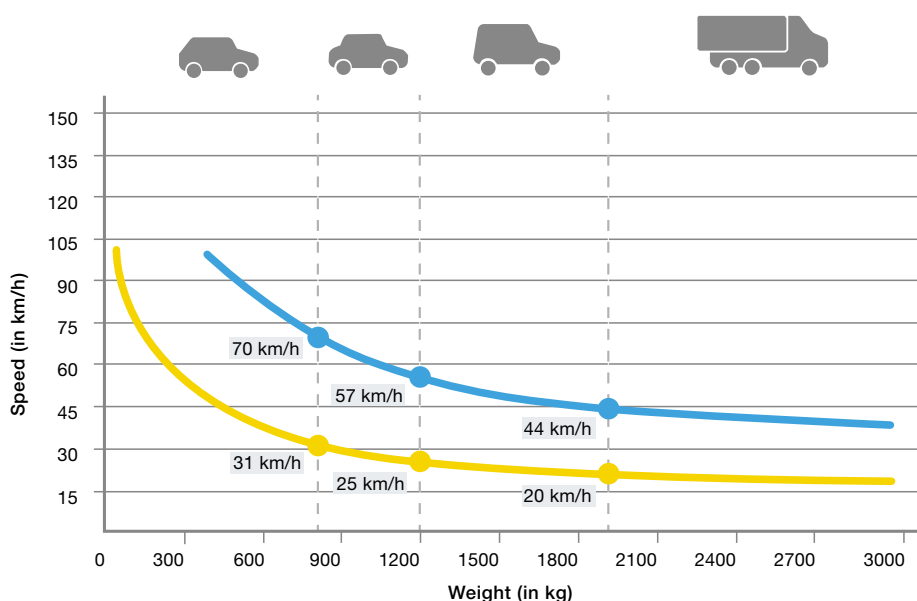





20

Security bollards



22

Security Design bollards



24

High Security bollards



26

High Security road blockers
and tyre killers



26

High Security
Mobile vehicle blocker



TOP LEFT. Automatic bollard with hydraulic operator

BOTTOM LEFT. Fixed bollard with bottom plate

BOTTOM RIGHT. Fixed bollard with stone mantle



AUTOMATIC BOLLARDS. Automatic bollards are available in two versions: one version with an integrated electromechanical operator for average use frequencies and a variant with an integrated hydraulic operator for very frequent use. The RI-H automatic bollard offers a particularly high level of protection with reinforced cylinder material.

FIXED BOLLARDS. The fixed bollards with bottom plate have a matching appearance with automatic and semi-automatic bollards. If damaged, the cylinders can be removed. The fixed bollards with ground anchor make for an introductory model featuring an excellent price-performance ratio. Fixed bollards RI-FF with reinforced cylinder material and reinforced ground fitting are ideal for particularly high protection.

SECURITY LINE BOLLARDS WITH STONE MANTLE. For unique design possibilities, we offer fixed and automatic bollards with a diameter of 275 mm in many stone types and colours as well as individual cylinder covers.

- For further information on the Security Line automatic bollards, see from page 30.
- For further information on the Security Line fixed bollards, see from page 35.
- For further information on the equipment options for bollards, see from page 50.



SEMI-AUTOMATIC BOLLARDS. Semi-automatic bollards with integrated gas springs are suitable for less frequent use. Installation does not require a power connection.

REMOVABLE BOLLARDS. Removable bollards, which can be detached without any tools, are recommended for very infrequent use of approximately two cycles per day.

DESIGN BOLLARDS. The new Design bollards are a simple, elegant and cost-effective solution for separating pavements, pedestrian areas or public spaces from road traffic. They are primarily arranged in a row to prevent cars from parking or driving between them, for example. Pedestrians and cyclists still have barrier-free access.

→ For further information on the Security Line semi-automatic and removable bollards, see from page 33.

→ For further information on the Design bollard, see from page 38.





TOP RIGHT. Removable bollard with round bottom plate

BOTTOM LEFT. Semi-automatic bollard with pavement frame

BOTTOM RIGHT. Design bollard with chamfered cover

HIGH SECURITY BOLLARDS. High Security Line bollards are perfect for protecting sensitive areas. They are available in automatic, semi-automatic, removable and fixed versions, are certified to international crash tests and meet the relevant security requirements.

→ For further information on the crash test conditions, see page 15.



TOP RIGHT. Electromechanical High Security bollard made of steel with LED lighting strip

BOTTOM LEFT. Hydraulic High Security bollard in painted steel





ELECTROMECHANICAL HIGH SECURITY BOLLARDS.

The High Security bollards with brushless electromechanical operator are the optimum solution in case of particularly strict environmental protection requirements, since they do not require hydraulic oil. Very easy to maintain and service. The Soft-Start and Soft-Stop function makes cylinder movements very gentle.

→ For further information on the High Security bollards, see from page 40.



TOP LEFT. Tyre killer M

TOP RIGHT. OktaBlock mobile vehicle blocker

BOTTOM. Road Blocker 1000 with hydraulic operator





ROAD BLOCKERS. For optimised security for entrances and exits up to six metres wide, road blockers are recommended. They are available in the Road Blocker 500 variant with a barrier height of 500 mm or in the Road Blocker 1000 version with a barrier height of 1000 mm. Road Blockers 500 SF and 1000 SF can easily and quickly be fitted on any suitable ground surface as they do not require excavation work.

TYRE KILLERS. Tyre killers enable controlled, uni-directional passage while preventing passage in the other direction. While the variant Tyre Killer M can always be traversed in one direction, Tyre Killer H is lowered to allow vehicle passage.

OKTABLOCK MOBILE VEHICLE BLOCKER. The Hörmann OktaBlock mobile vehicle blocker secures driveways and access to open-air events and effectively prevents vehicles from smashing through. Its design is inconspicuous, and is therefore not perceived to be threatening. Whether it's a city festival in springtime, a summer festival or a Christmas market in winter, mobile vehicle blockers allow different events to be secured in a location-independent and cost-efficient way at flexible times.

- For further information on road blockers and tyre killers, see from page 54.
- For further information on the OktaBlock, see from page 58.





38



56

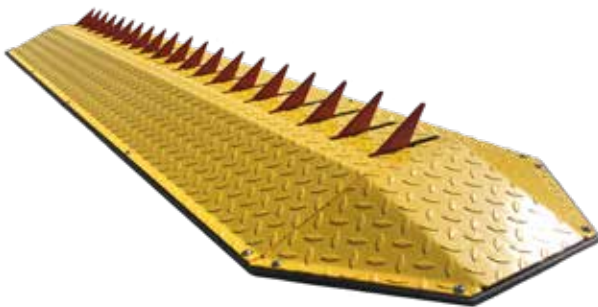

58



Versions. Accessories. Technology.

- 30 Automatic bollards | Security Line
- 33 Semi-automatic bollards | Security Line
- 34 Removable bollards | Security Line
- 35 Fixed bollards | Security Line
- 38 Design bollards | Security Line
- 40 Automatic bollards | High Security Line
- 42 Semi-automatic bollards | High Security Line
- 43 Removable bollards | High Security Line
- 44 Fixed bollards | High Security Line
- 46 Fixed bollards with flat ground fitting | High Security Line
- 50 Equipment for bollards
- 54 Road blockers | High Security Line
- 56 Tyre killers | High Security Line
- 57 Equipment for road blockers and tyre killers
- 58 OktaBlock mobile vehicle blocker
- 62 Hörmann Access Control (HAC)
- 63 Key switch posts
- 64 Accessories

Automatic bollards E

With integrated electromechanical operator



- For average use frequencies (approx. 100 cycles / day)
- Introductory model featuring an excellent price-performance ratio
- Automatic lifting and lowering by integrated electromechanical operator
- Control unit for controlling max. three bollards
- Distance between bollard and control unit of up to 30 m



	A 275-600 E	A 275-800 E
Diameter (mm)	273	273
Height (mm)	600	800
Technical data		
Speed, lifting (cm/s)	9,5	11
Speed, lowering (cm/s)	12	14
Load class acc. to EN 124	D400 (40 tonnes)	D400 (40 tonnes)
Automatic lowering in case of power failure (via battery)	●	●
Automatic safety cut-out (can be deactivated)	●	●
Integrated electromechanical operator	●	●
Cycles (approx. per day)	100	100
Overall cycles (max. service life)	200000	200000
Impact energy with destruction (J)	150000	150000
Impact energy without destruction (J)	20000	20000
Temperature range	-40 °C to +70 °C*	-40 °C to +70 °C*

● = Standard equipment ○ = Optional equipment -- = Not available
 *For temperatures below -10°C, we recommend an optional heater

For information about the equipment options, see pages 50 – 53.

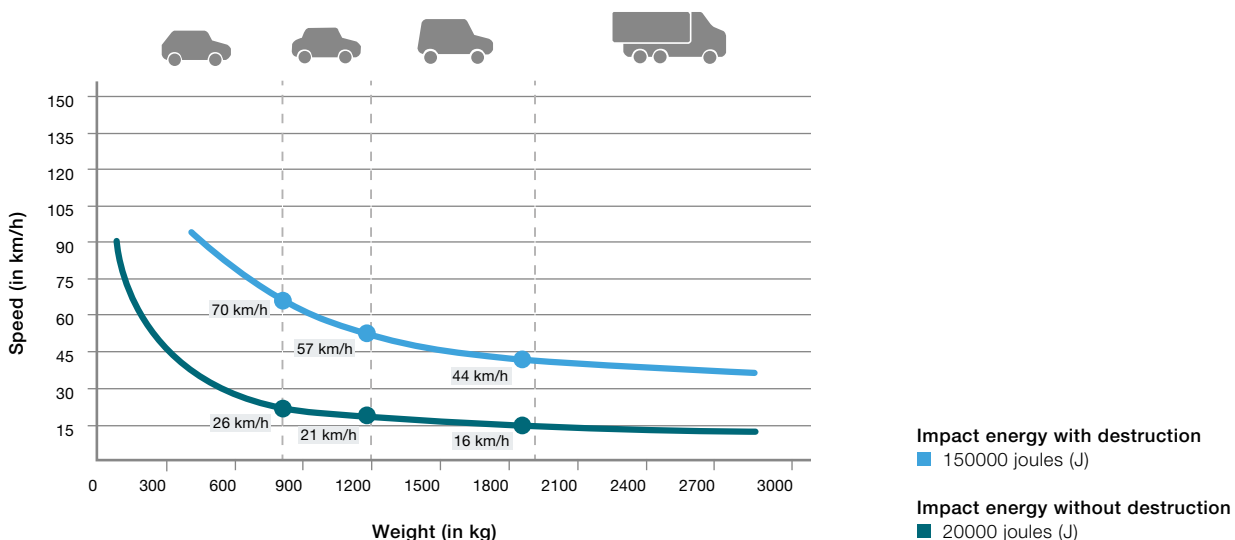



Automatic bollards H

With integrated hydraulic operator

- For high use frequencies (approx. 2000 cycles / day)
- Automatic lifting and lowering by integrated hydraulic operator
- A 275-600 / A 275-800 H: NEW. Optional: all major components made of stainless steel
- Control unit can be extended to control multiple bollards simultaneously
- Distance between bollard and control unit of up to 80 m



	A 220-600 H	A 220-800 H	A 275-600 H	A 275-800 H
Diameter (mm)	220	220	273	273
Height (mm)	600	800	600	800

Technical data

Speed, lifting (cm/s)	15	15	16	17
Speed, lowering (cm/s)	30	25	30	32
Load class acc. to EN 124	D400 (40 tonnes)	D400 (40 tonnes)	D400 (40 tonnes)	D400 (40 tonnes)
Manual emergency lowering in case of power failure	●	●	●	●
Automatic lowering in case of power failure	○	○	○	○
Automatic safety cut-out (can be deactivated)	●	●	●	●
Integrated hydraulic operator	●	●	●	●
Cycles (approx. per day)	2000	2000	2000	2000
Overall cycles (max. service life)	3000000	3000000	3000000	3000000
Impact energy with destruction (J)	150000	150000	250000	250000
Impact energy without destruction (J)	30000	30000	40000	40000
Temperature range	-40 °C to +70 °C*	-40 °C to +70 °C*	-40 °C to +70 °C*	-40 °C to +70 °C*

● = Standard equipment ○ = Optional equipment – = Not available
 * For temperatures below -10°C, we recommend an optional heater

For information about the equipment options, see pages 50 – 53.

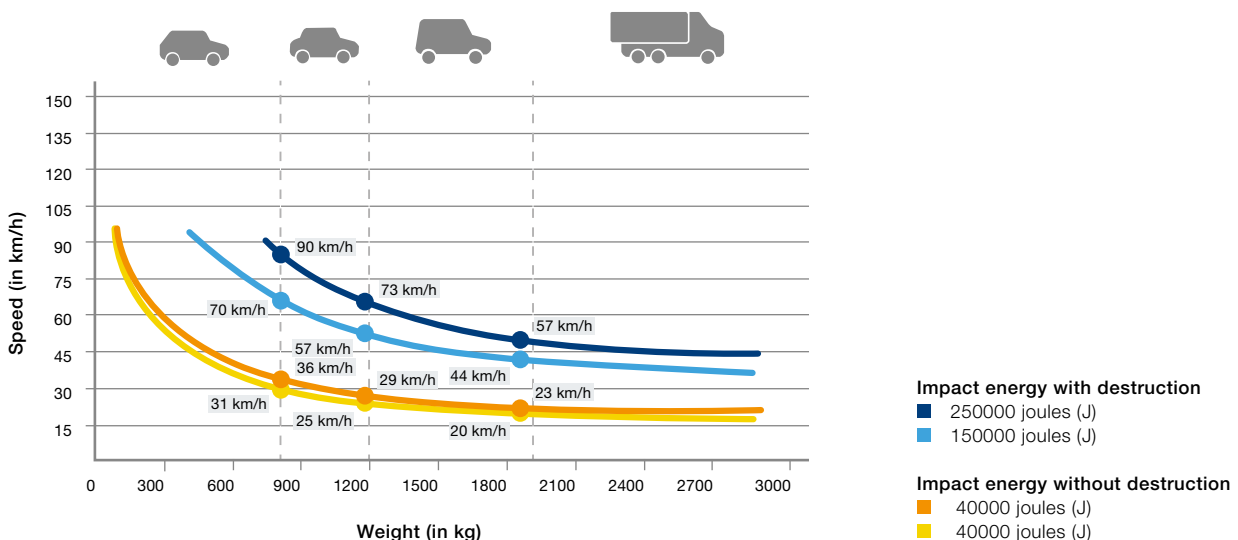

Automatic bollards RI-H

With integrated hydraulic operator



- For high use frequencies (approx. 2000 cycles / day)
- Especially high protection level thanks to reinforced cylinder material
- Automatic lifting and lowering by integrated hydraulic operator
- Optionally with EFO emergency function (Emergency Fast Operation)
- Control unit can be extended to control multiple bollards simultaneously
- Distance between bollard and control unit of up to 80 m



	A 275-RI-600 H	A 275-RI-800 H
Diameter (mm)	273	273
Height (mm)	600	800
Technical data		
Speed, lifting (cm/s)	15	16
Speed, lowering (cm/s)	30	32
Load class acc. to EN 124	D400 (40 tonnes)	D400 (40 tonnes)
Manual emergency lowering in case of power failure	●	●
Automatic lowering in case of power failure	○	○
EFO emergency function	○	○
Automatic safety cut-out (can be deactivated)	●	●
Integrated hydraulic operator	●	●
Cycles (approx. per day)	2000	2000
Overall cycles (max. service life)	3000000	3000000
Impact energy with destruction (J)	400000	400000
Impact energy without destruction (J)	40000	40000
Temperature range	-40 °C to +70 °C*	-40 °C to +70 °C*

● = Standard equipment ○ = Optional equipment – = Not available
 *For temperatures below -10°C, we recommend an optional heater

For information about the equipment options, see pages 50 – 53.

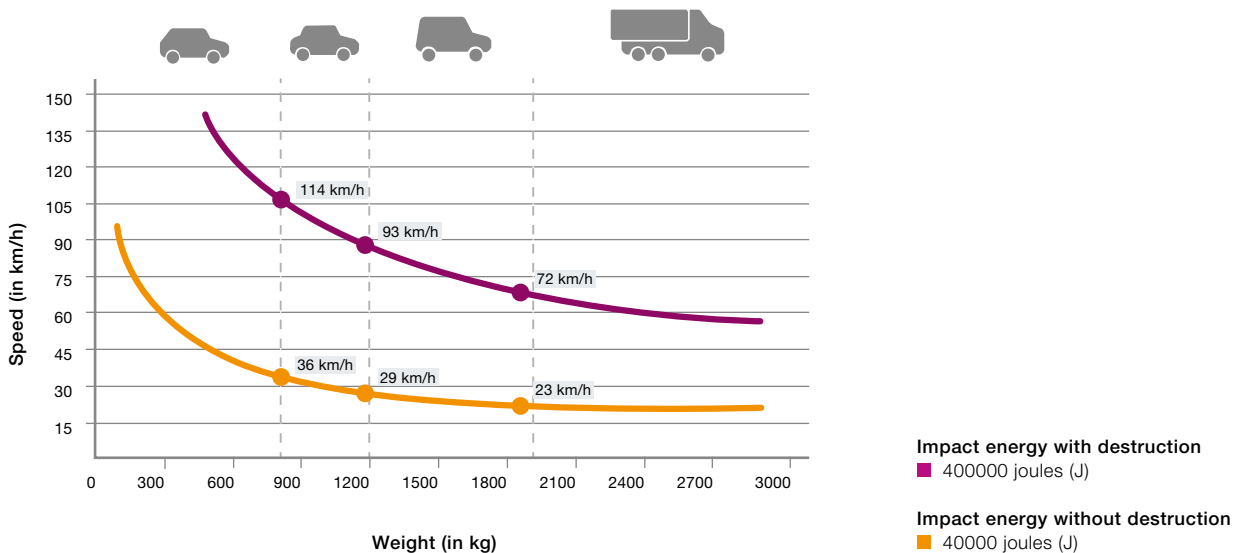



Semi-automatic bollards G

With integrated gas spring

- For less frequent use (approx. five cycles / day)
- No power supply required
- Manual lowering of bollard by depressing it, automatic lifting by integrated gas spring
- Distance between bollard and control unit of up to 80 m



	S 220-600 G	S 220-800 G	S 275-600 G	S 275-800 G
Diameter (mm)	220	220	273	273
Height (mm)	600	800	600	800

Technical data

Speed, lifting (cm/s)	20	20	20	20
Speed, lowering	Manual	Manual	Manual	Manual
Load class acc. to EN 124	D400 (40 tonnes)	D400 (40 tonnes)	D400 (40 tonnes)	D400 (40 tonnes)
Integrated gas spring	●	●	●	●
Cycles (approx. per day)	5	5	5	5
Overall cycles (max. service life)	3000000	3000000	3000000	3000000
Impact energy with destruction (J)	150000	150000	250000	250000
Impact energy without destruction (J)	30000	30000	30000	30000
Temperature range	-40 °C to +70 °C*	-40 °C to +70 °C*	-40 °C to +70 °C*	-40 °C to +70 °C*

● = Standard equipment ○ = Optional equipment – = Not available
 * For temperatures below -10°C, we recommend an optional heater

For information about the equipment options, see pages 50 – 53.

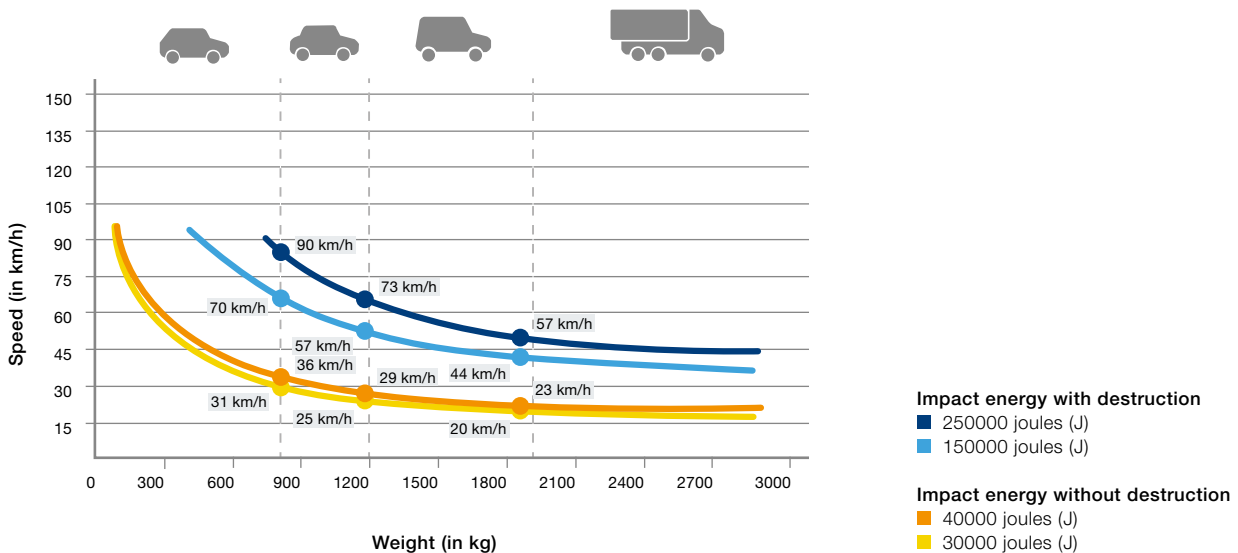

Removable bollards

With closed socket



- For very infrequent use (approx. two cycles / day)
- Can be detached without tools
- Ground-level fitting
- Locking via security lock with profile half cylinder
- No opening in the ground when bollard is removed

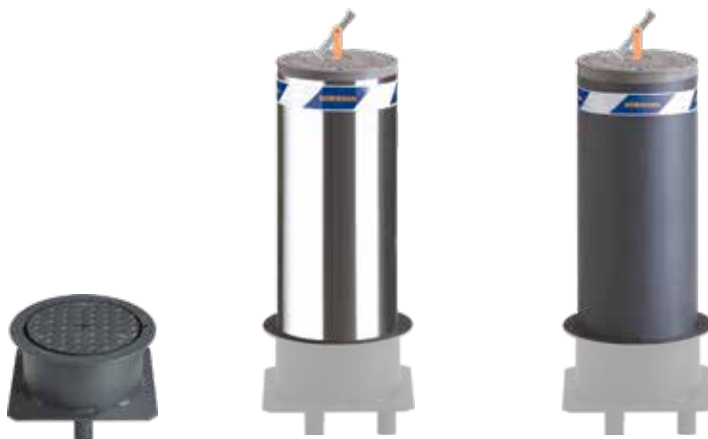

	R 275-600	R 275-800
Diameter (mm)	273	273
Height (mm)	600	800

Technical data

Cycles (approx. per day)	2	2
Impact energy with destruction (J)	200000	200000
Impact energy without destruction (J)	40000	40000

● = Standard equipment ○ = Optional equipment – = Not available

For information about the equipment options, see pages 50 – 53.

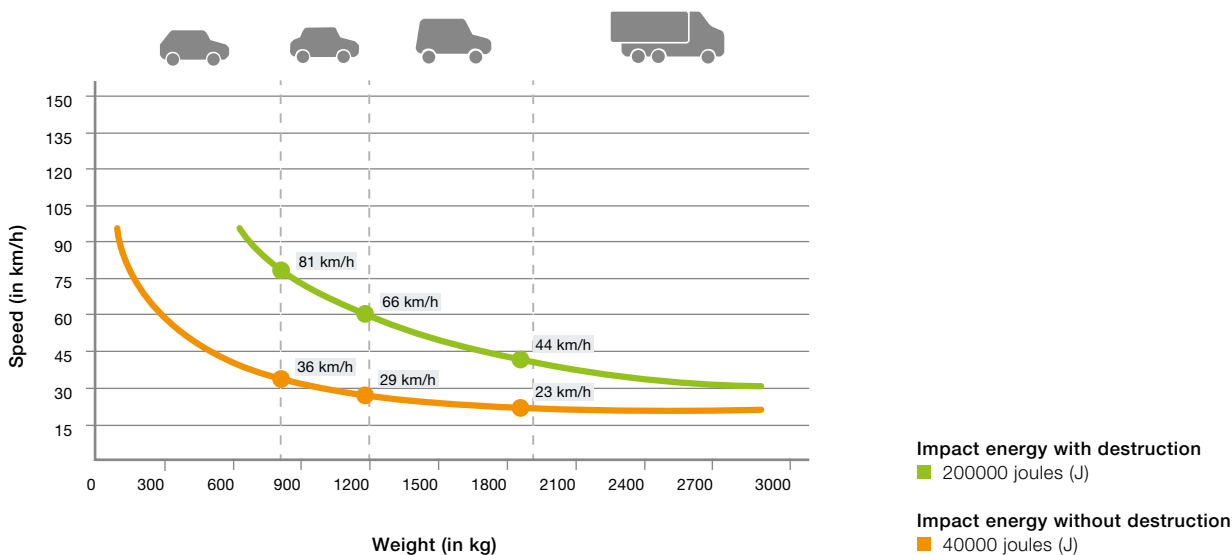



Fixed bollards CF

With bottom plate

- Harmonious look in combination with automatic and semi-automatic bollards thanks to matching bottom plate
- Simple cylinder removal in case of damage or special events
- Optionally with LED lighting strip for improved visibility



	F 220-600 CF	F 220-800 CF	F 275-600 CF	F 275-800 CF
Diameter (mm)	220	220	275	275
Height (mm)	600	800	600	800

Technical data

Impact energy with destruction (J)	150000	150000	250000	250000
Impact energy without destruction (J)	30000	30000	40000	40000

● = Standard equipment ○ = Optional equipment – = Not available

For information about the equipment options, see pages 50 – 53.

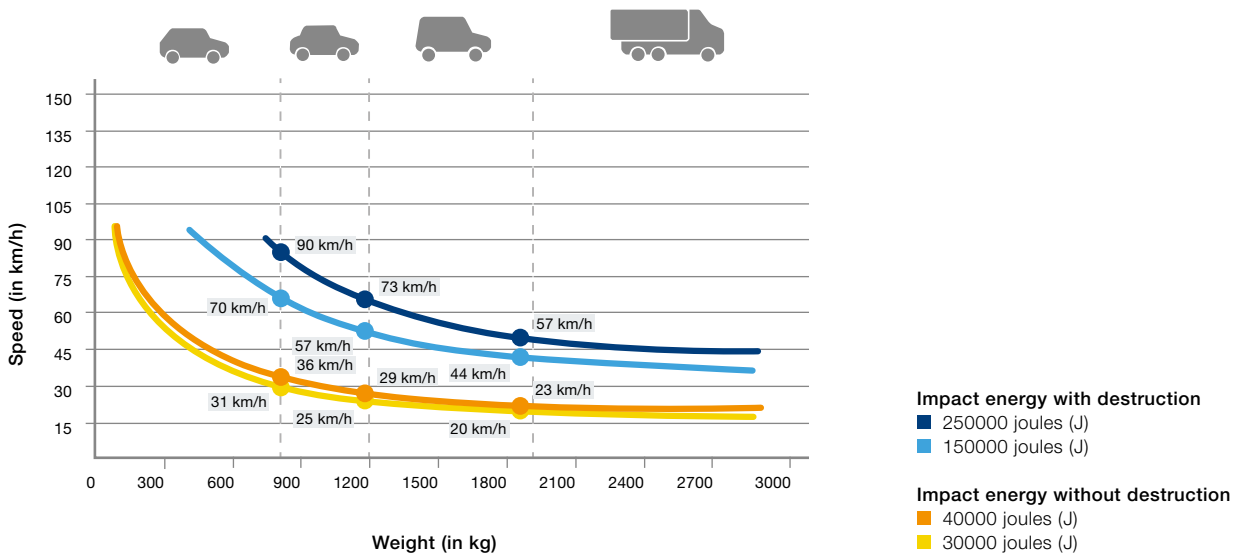

Fixed bollards BR

With ground anchor



- Introductory model featuring an excellent price-performance ratio
- To secure buildings or areas without requiring a driveway
- For combination with automatic and removable Security bollards using cylinders in matching appearance



	F 220-600 BR	F 220-800 BR	F 275-600 BR	F 275-800 BR
Diameter (mm)	220	220	273	273
Height (mm)	600	800	600	800
Technical data				
Impact energy with destruction (J)	150000	150000	250000	250000
Impact energy without destruction (J)	30000	30000	40000	40000

● = Standard equipment ○ = Optional equipment – = Not available

For information about the equipment options, see pages 50 – 53.

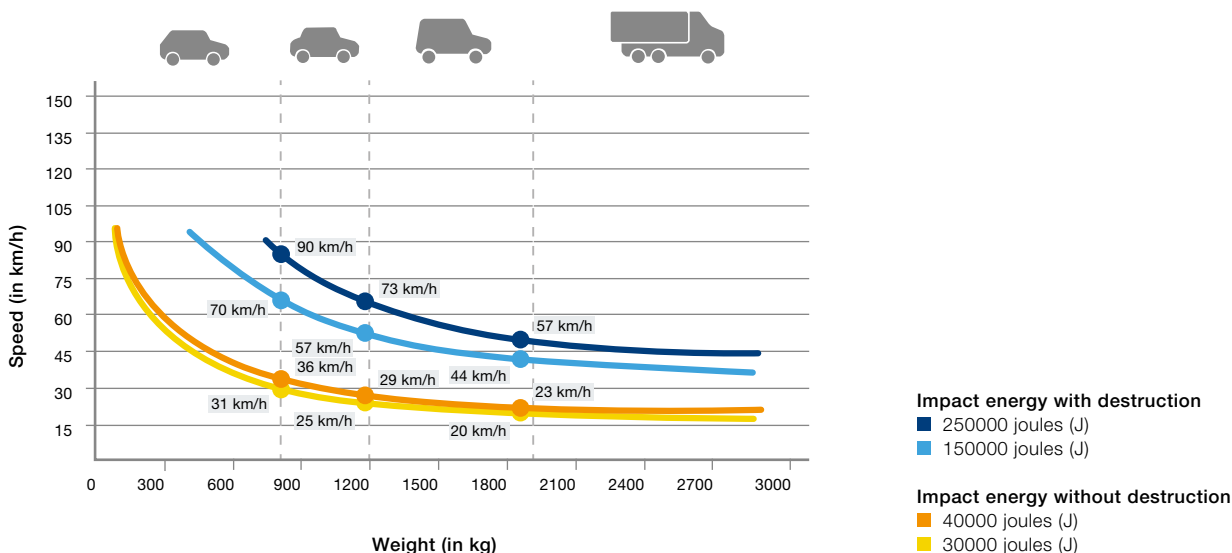



Fixed bollards RI-FF

With reinforced ground fitting

- Especially high protection level thanks to reinforced cylinder material and reinforced ground fitting
- To secure buildings or areas without requiring a driveway
- For combination with automatic and removable Security bollards using cylinders in matching appearance



	F 275-RI-600 FF	F 275-RI-800 FF
Diameter (mm)	273	273
Height (mm)	600	800
Technical data		
Impact energy with destruction (J)	400000	400000
Impact energy without destruction (J)	40000	40000

● = Standard equipment ○ = Optional equipment – = Not available

For information about the equipment options, see pages 50 – 53.

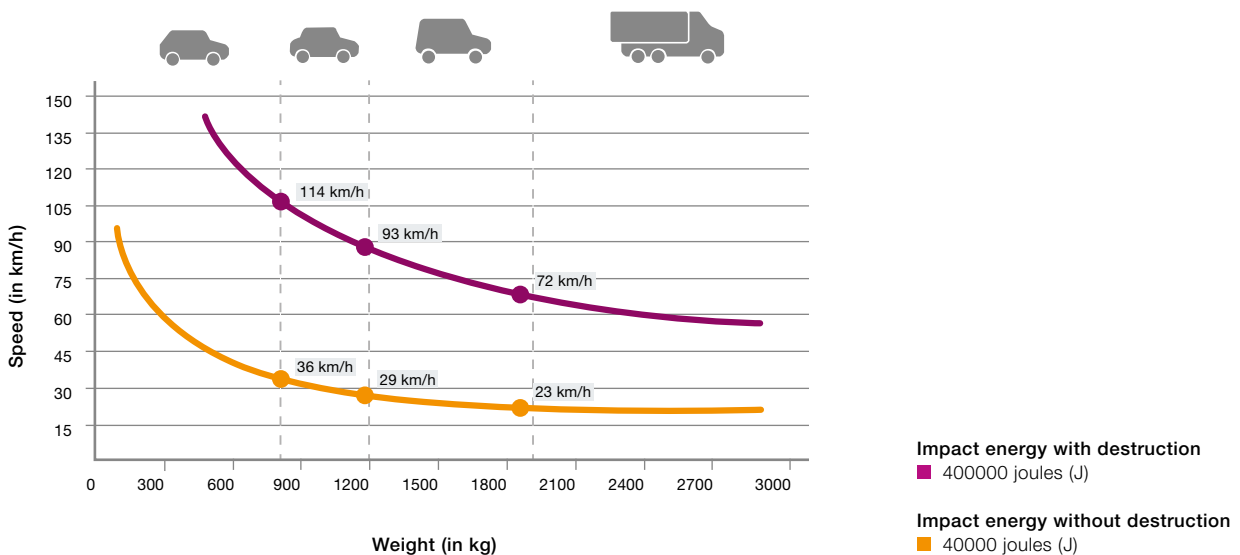

Design bollards

In five elegant versions

- Distinguished Design bollards optionally in a coated steel version or with an elegant stainless steel surface
- Five designs and three different diameters for a harmonious appearance
- Simple fitting by setting in concrete or version with screw-on flange for bolt fastening



Fig. shows version with reinforced ground fitting for setting in concrete

	F 102-900	F 140-900	F 168-900
Diameter (mm)	102	140	168
Height (mm)	900	900	900
Steel, coated in RAL 7016 Anthracite grey	●	●	●
Brushed stainless steel, V2A (AISI 304)	●	●	●
Coating in RAL to choose (for steel version)	○	○	○

Technical data

With straight cover (see figure above)	●	●	●
With concave cover	○	○	○
With chamfered cover	○	○	○
With wide ring	○	○	○
With 4 × ring	○	○	○
Ground fitting for setting in concrete, fitting depth 150 mm (F 102-900, F 102-900) / 250 mm (F 168-900)	●	●	●
Cylinder extension in 100 mm intervals up to max. 1200 mm	○	○	○
Reinforced cylinder and reinforced ground fitting	○	○	○
Screw-on flange for bolt fastening	○	○	○
Impact energy with destruction* (J)	200000	200000	200000

● = Standard equipment ○ = Optional equipment – = Not available

* Applies only for bollards with reinforced cylinder and reinforced ground fitting

Optional equipment

- Version with concave cover **1**
- Version with chamfered cover **2**
- Version with wide ring
(only in stainless steel version) **3**
- Version with quadruple ring
(only in stainless steel version) **4**
- Version with screw-on flange
for bolt fastening **5**



Automatic bollards E

With brushless electromechanical operator

Only from Hörmann
High Security bollards with brushless electromechanical operator



- For high use frequencies (approx. 2000 cycles / day)
- Low maintenance, as no inspection of the hydraulics components, oil pressure and oil level is required
- Environmentally friendly, can also be used in case of strict environmental requirements
- Service-friendly thanks to virtually wear-free brushless 230 V operators and few operator components
- Low-vibration and low-noise cylinder movement with Soft-Start and Soft-Stop
- Optionally with EFO emergency function (Emergency Fast Operation)



	A 275-M30-900 E	A 275-M30-1200 E	A 275-M50-900 E	A 275-M50-1200 E
Diameter (mm)	273	273	271	271
Height (mm)	900	1200	900	1200
Technical data				
Speed, lifting (cm/s)	22	22	22	22
Speed, lowering (cm/s)	22	22	22	22
Load class acc. to EN 124	D400 (40 tonnes)	D400 (40 tonnes)	D400 (40 tonnes)	D400 (40 tonnes)
Manual lowering in case of power failure	●	●	●	●
Automatic lowering in case of power failure (via battery)	○	○	○	○
EFO emergency function	○	○	○	○
Electromechanical operator	●	●	●	●
Cycles (approx. per day)	2000	2000	2000	2000
Overall cycles (max. service life)	3000000	3000000	3000000	3000000
Certified acc. to	PAS68, IWA14-1, M30, K4	PAS68, IWA14-1, M30, K4	PAS68, IWA14-1, M50, K12	M50, K12, PAS68
Compliant with	-	-	-	IWA14-1
Impact energy with destruction (J)	750000	1200000	2000000	2000000
Impact energy without destruction (J)	250000	700000	700000	700000
Temperature range	-40 °C to +70 °C*	-40 °C to +70 °C*	-40 °C to +70 °C*	-40 °C to +70 °C*

● = Standard equipment ○ = Optional equipment - = Not available
*For temperatures below -10°C, we recommend an optional heater

For information about the equipment options, see pages 50 – 53.

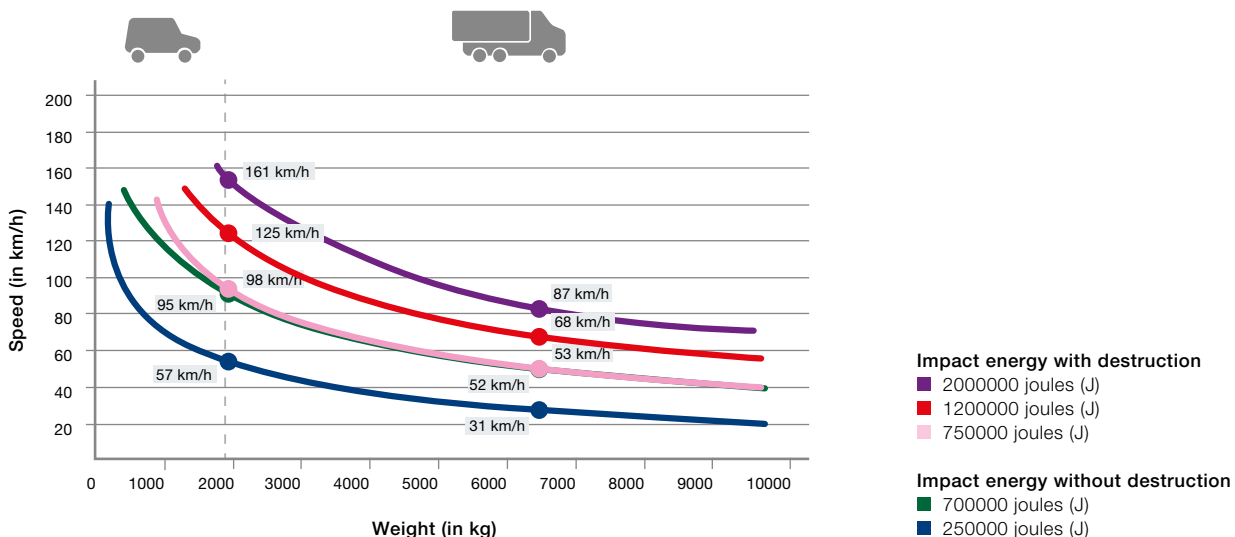



Automatic bollards H

With integrated hydraulic operator

- For high use frequencies (approx. 2000 cycles / day)
- Automatic lifting and lowering by integrated hydraulic operator
- Optionally with EFO emergency function (Emergency Fast Operation)
- Control unit can be extended to control multiple bollards simultaneously
- Distance between bollard and control unit of up to 80 m



	A 275-M30-900 H	A 275-M30-1200 H	A 275-M50-900 H	A 275-M50-1200 H
Diameter (mm)	273	273	271	271
Height (mm)	900	1200	900	1200
Technical data				
Speed, lifting (cm/s)	10	22	22	22
Speed, lowering (cm/s)	26	30	22	30
Load class acc. to EN 124	D400 (40 tonnes)	D400 (40 tonnes)	D400 (40 tonnes)	D400 (40 tonnes)
Manual lowering in case of power failure	●	●	●	●
EFO emergency function	○	○	○	○
Integrated hydraulic operator	●	●	●	●
Cycles (approx. per day)	2000	2000	2000	2000
Overall cycles (max. service life)	3000000	3000000	3000000	3000000
Certified acc. to	PAS68, IWA14-1, M30, K4	PAS68, IWA14-1, M30, K4	PAS68, IWA14-1, M50, K12	M50, K12, PAS68
Compliant with	-	-	-	IWA14-1
Impact energy with destruction (J)	750000	1200000	2000000	2000000
Impact energy without destruction (J)	250000	700000	700000	700000
Temperature range	-40 °C to +70 °C*	-40 °C to +70 °C*	-40 °C to +70 °C*	-40 °C to +70 °C*

● = Standard equipment ○ = Optional equipment - = Not available
 * For temperatures below -10°C, we recommend an optional heater

For information about the equipment options, see pages 50 – 53.

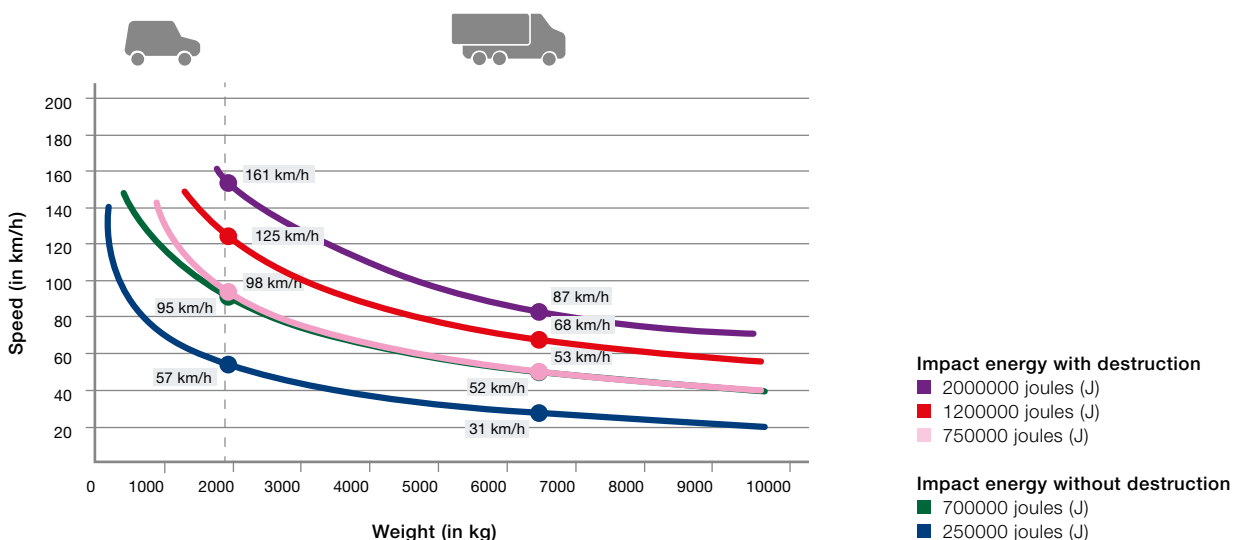

Semi-automatic bollards H

With integrated hydraulic pump



- For less frequent use (approx. five cycles / day)
- No power supply required
- Manual lowering and lifting with electric screwdriver using supplied special insert



	S 275-M30-900 H	S 275-M30-1200 H	S 275-M50-900 H	S 275-M50-1200 H
Diameter (mm)	273	273	271	271
Height (mm)	900	1200	900	1200
Technical data				
Speed, lifting (cm/s)	8	8	8	8
Speed, lowering (cm/s)	20	20	20	20
Load class acc. to EN 124	D400 (40 tonnes)	D400 (40 tonnes)	D400 (40 tonnes)	D400 (40 tonnes)
EFO emergency function	○	○	○	○
Integrated hydraulic operator	●	●	●	●
Cycles (approx. per day)	5	5	5	5
Overall cycles (max. service life)	3000000	3000000	3000000	3000000
Certified acc. to	PAS68, IWA14-1, M30, K4	PAS68, IWA14-1, M30, K4	PAS68, IWA14-1, M50, K12	M50, K12, PAS68
Compliant with	-	-	-	IWA14-1
Impact energy with destruction (J)	750000	1200000	2000000	2000000
Impact energy without destruction (J)	250000	700000	700000	700000
Temperature range	-40 °C to +70 °C*	-40 °C to +70 °C*	-40 °C to +70 °C*	-40 °C to +70 °C*

● = Standard equipment ○ = Optional equipment - = Not available
 * For temperatures below -10°C, we recommend an optional heater

For information about the equipment options, see pages 50 – 53.

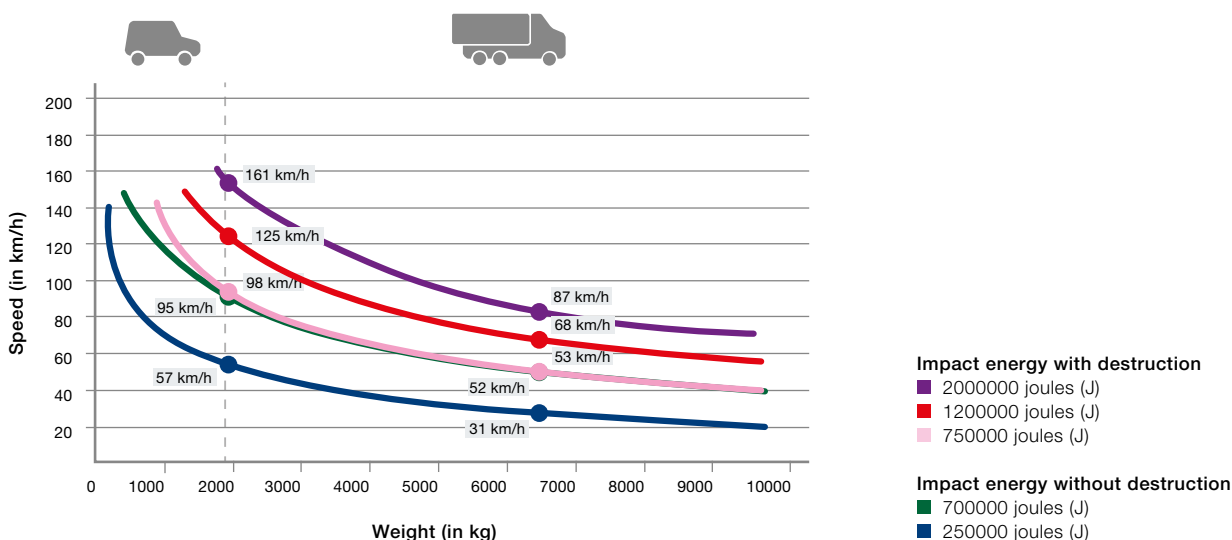



Removable bollards

With reinforced socket

- For very infrequent use
- Removable using special tool
- Locking via security lock with profile half cylinder
- Can be combined with fixed High Security bollards using cylinders in matching appearance



	R 275-M30-900	R 275-M30-1200	R 275-M50-900	R 275-M50-1200
Diameter (mm)	273	273	271	271
Height (mm)	900	1200	900	1200
Technical data				
Certified acc. to	PAS68, IWA14-1, M30, K4	PAS68, IWA14-1, M30, K4	-	-
Compliant with	-	-	PAS68, IWA14-1, M50, K12	PAS68, IWA14-1, M50, K12
Impact energy with destruction (J)	750000	750000	2000000	2000000
Impact energy without destruction (J)	100000	100000	250000	250000

● = Standard equipment ○ = Optional equipment - = Not available

For information about the equipment options, see pages 50 – 53.

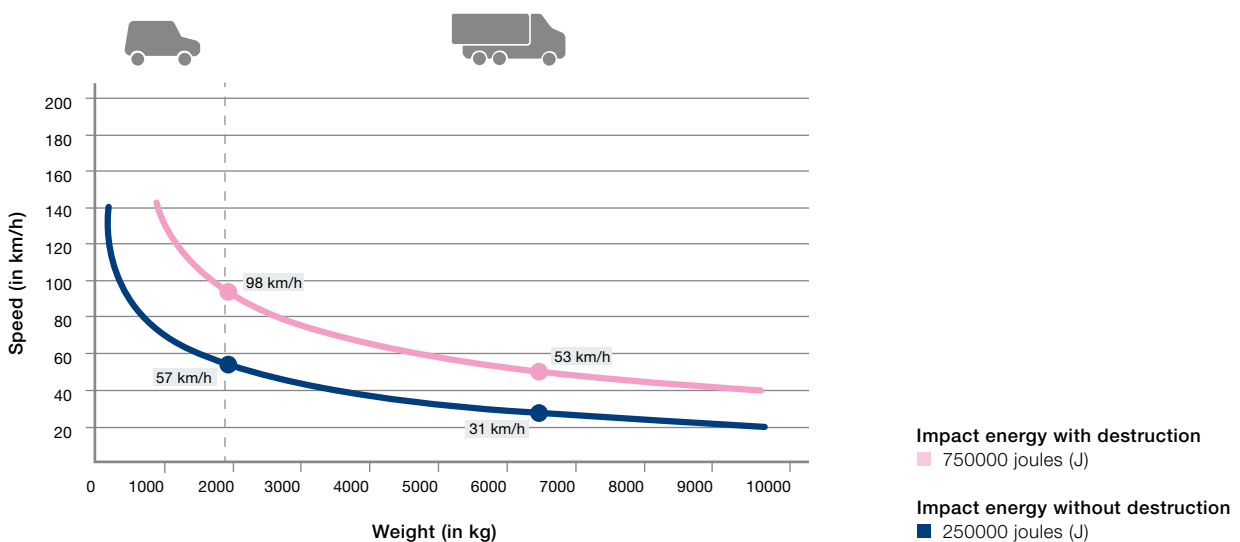

Fixed bollards FF

With reinforced ground fitting



- Reinforced ground fitting for setting in concrete
- To secure buildings or areas without requiring a driveway
- For combination with automatic and removable High Security bollards using cylinders in matching appearance
- Rectangular bottom plate for combining with automatic bollards
- **NEW.** Steel cylinder with exchangeable stainless steel sleeve as an alternative to the full stainless steel cylinder version



	F 275-M30-900 FF	F 275-M30-1200 FF	F 275-M50-900 FF	F 275-M50-1200 FF
Diameter (mm)	273	273	271	271
Height (mm)	900	1200	900	1200

Technical data

NEW. Certified acc. to	M30, K4, PAS68, IWA14-1	M30, K4, PAS68, IWA14-1	M50, K12, PAS68, IWA14-1	M50, K12, PAS68, IWA14-1
Impact energy with destruction (J)	750000	1200000	2000000	2000000
Impact energy without destruction (J)	250000	700000	700000	700000

● = Standard equipment ○ = Optional equipment -- = Not available

For information about the equipment options, see pages 50 – 53.

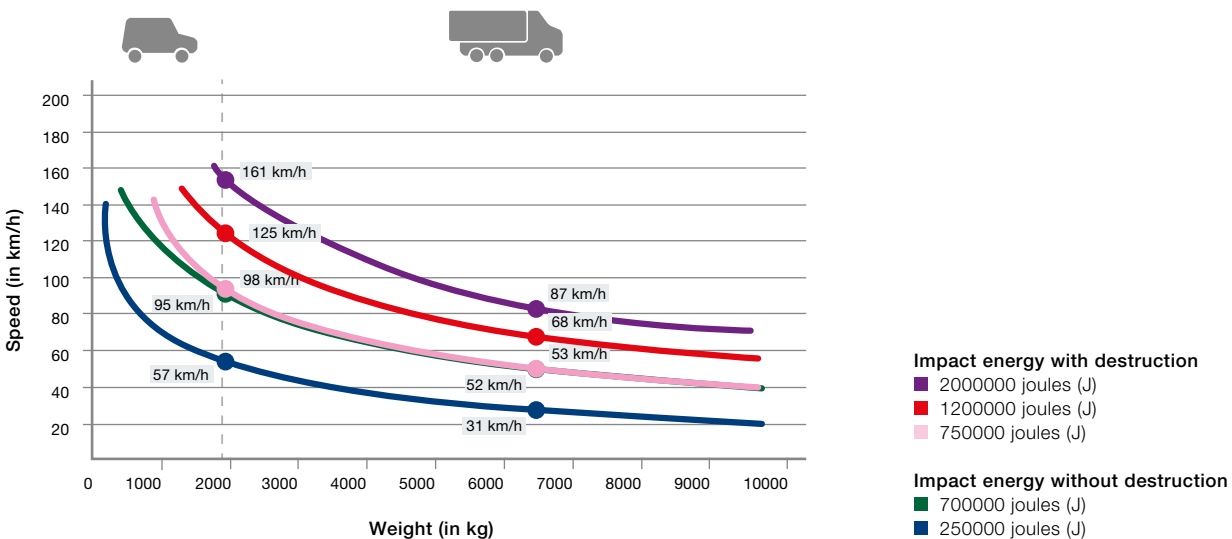



Fixed bollards ST . NEW

For cost-effective securing of large premises

- Certified protection with optimum price-performance ratio
- For securing large surface areas
- For combination with automatic and removable High Security bollards using cylinders in matching appearance or alternatively with bollard head with welded cover
- Optionally with LED lighting strip for improved visibility
- Rectangular bottom plate for combining with automatic bollards
- **NEW.** Steel cylinder with exchangeable stainless steel sleeve as an alternative to the full stainless steel cylinder version



	F 275-M30-900 ST	F 275-M30-1200 ST	R 275-M50-900 ST	R 275-M50-1200 ST
Diameter (mm)	273	273	271	271
Height (mm)	900	1200	900	1200
Technical data				
Certified acc. to	PAS68	PAS68	-	-
Compliant with	IWA14-1, M30, K4	IWA14-1, M30, K4	IWA14-1, M50, K12	IWA14-1, M50, K12
Impact energy with destruction (J)	750000	750000	2000000	2000000
Impact energy without destruction (J)	250000	250000	700000	700000

● = Standard equipment ○ = Optional equipment -- = Not available

For information about the equipment options, see pages 50 – 53.

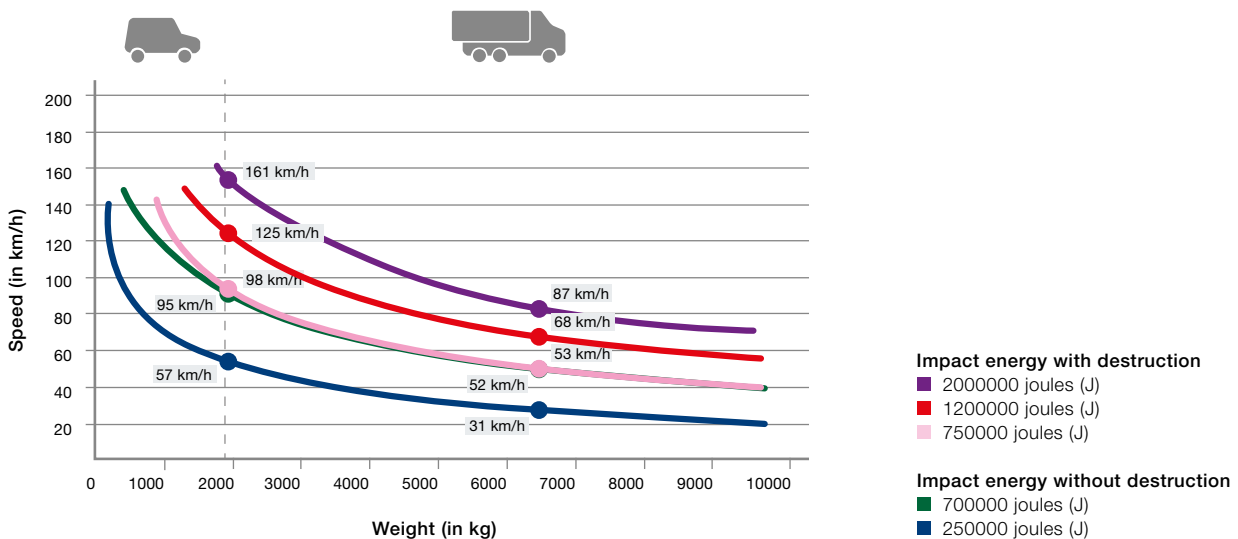

Fixed bollards SF

M30 with flat ground fitting and a fitting depth of only 200 mm

- For fitting over supply lines laid in the ground or e.g. over underground garages
- Very low fitting depth of only 200 mm for road surfaces with asphalt
- Optional: 300 mm fitting depth for road surfaces e.g. with paving stones
- Arrangement with any number of rows, with multiple bollards
- Custom angle arrangements at 90°, 45° and 30° angles
- Can also be used with gradients
- Harmonious appearance in combination with other High Security bollards thanks to matching cylinders
- Little earthworks and reduced assembly required thanks to ready-to-fit modules, including steel reinforcement

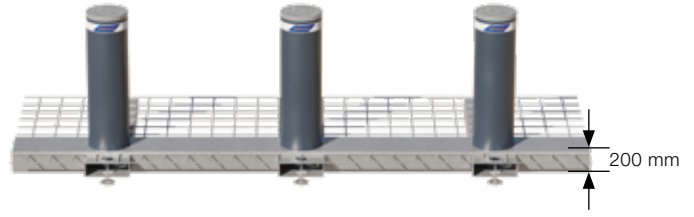

Standard ground fitting with **three fixed cylinders**

F 275-M30-900 SF

Diameter (mm)	273
Height (mm)	900
Fitting depth for combination with asphalt (standard)	200
Fitting depth e.g. for combination with paving stones (optional)	300

Technical data

Certified to (prerequisite: standard ground fitting for three cylinders)	PAS68, IWA14-1, M30, K4
Impact energy with destruction (J)	750000
Impact energy without destruction (J)	250000

● = Standard equipment ○ = Optional equipment – = Not available

For information about the equipment options, see pages 50 – 53.

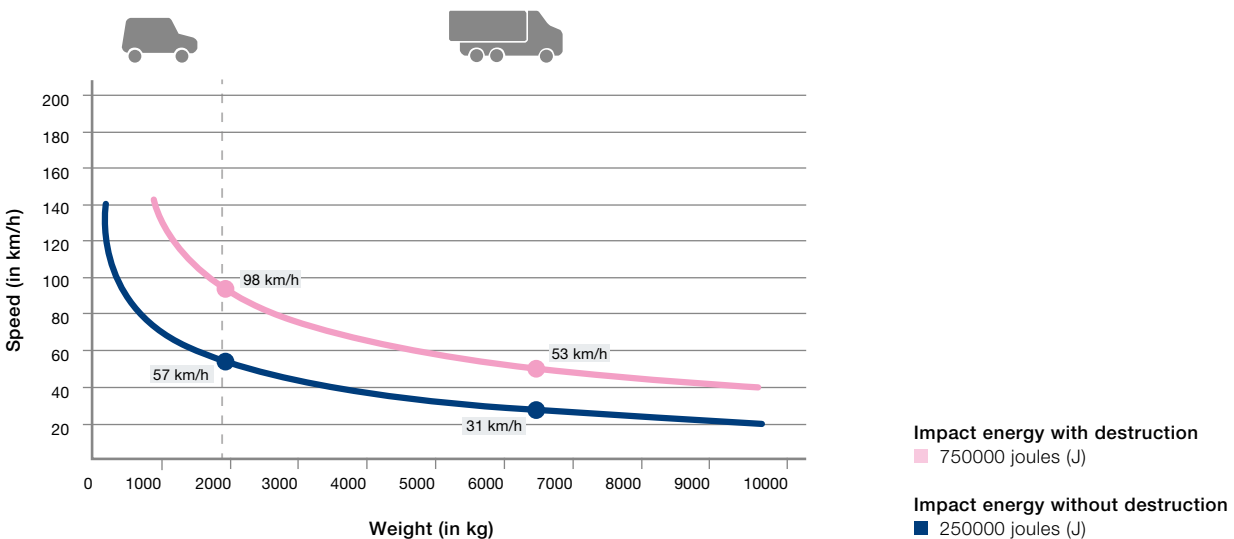

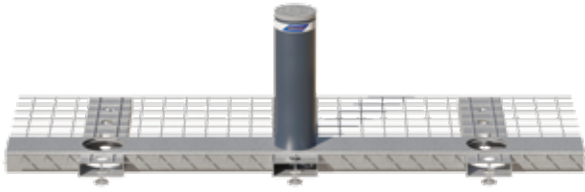

Standard ground fitting with **one fixed cylinder** (arrangement in direction of travel to centre), optionally on right or on left

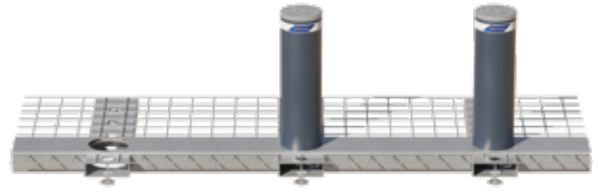

Standard ground fitting with **two fixed cylinders**, (arrangement in direction of travel to centre / right), arrangement in direction of travel to centre / left also possible

Extensions and arrangements

Modules with one or two bollards

Ground fitting with one bollard or two bollards **2** to extend the standard ground fitting

Module with three bollards in 90° arrangement **3**

Ground fitting in 90° angle arrangement with three fixed bollards

Angle arrangements **4**

Fitting set 0° / 30° / 45° to join ground fittings in case of an even surface

Inclining or sloping arrangement **5**

Fitting set to join ground fittings in case of surfaces with a gradient (also possible in combination with angle arrangement). The maximum possible gradient is approx. 2.4° (approx. 42 mm at a length of 1 m).

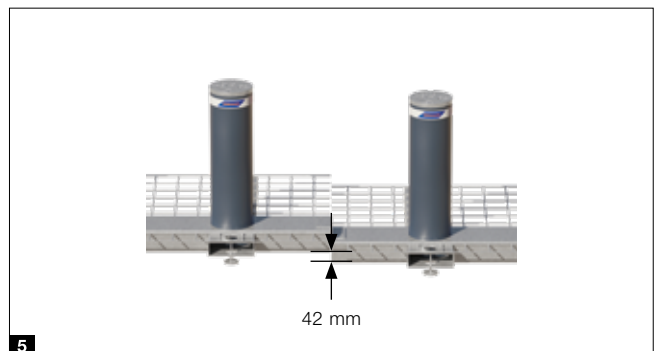
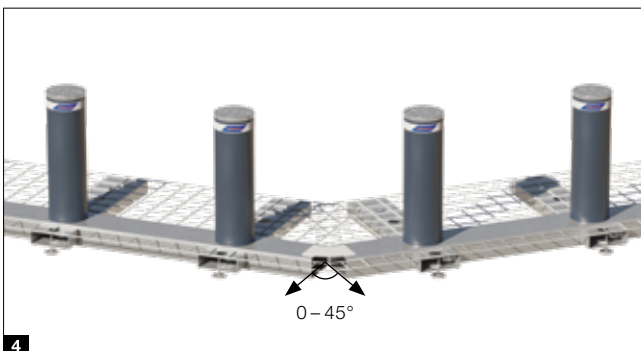
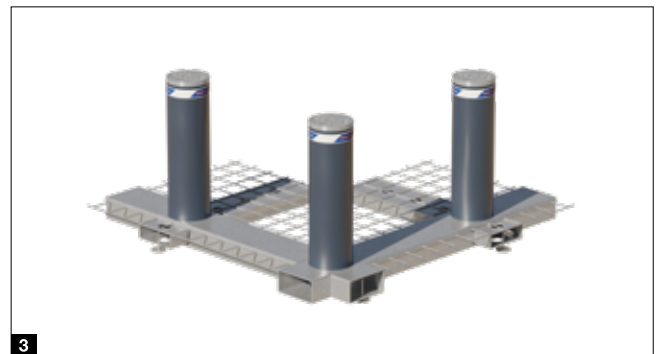
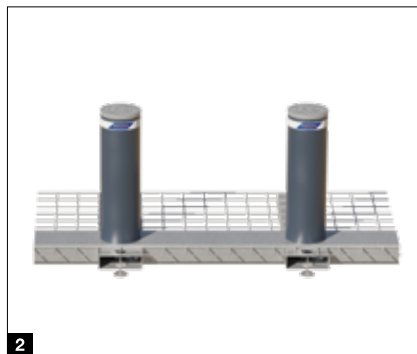
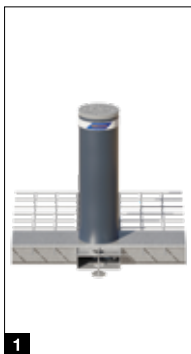

Fixed and removable bollards SF . NEW

M50 flat foundation bollards with only 200 mm fitting depth

- High level of protection with small fitting depth
- Fitting depth of only 200 mm
- Individual arrangement by combining several modules
- Optionally also available in a removable version:
R 275-M50-900 SF | R 275-M50-1200 SF
- Flexible, individual angled arrangements possible
- Optionally with LED lighting strip for improved visibility
- **NEW.** Steel cylinder with exchangeable stainless steel sleeve as an alternative to the full stainless steel cylinder version

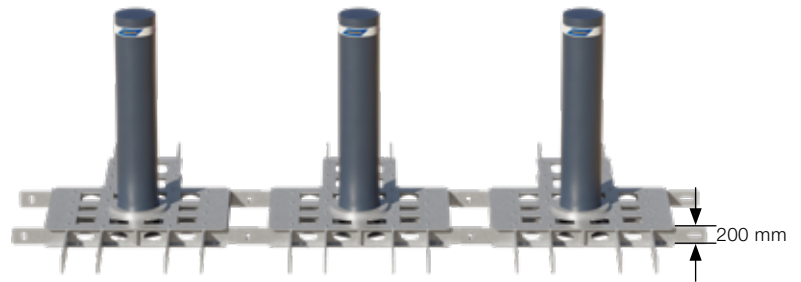

Standard ground fitting with **three fixed cylinders**

	NEW. F 275-M50-900 SF	NEW. F 275-M50-1200 SF
Diameter (mm)	271	271
Height (mm)	900	1200
Fitting depth for combination with asphalt (standard)	200	200
Fitting depth e.g. for combination with paving stones (optional)	300	300

Technical data

Certified to (prerequisite: standard ground fitting for three cylinders)	PAS68, IWA14-1, M50, K12	PAS68, IWA14-1, M50, K12
Impact energy with destruction (J)	2000000	2000000
Impact energy without destruction (J)	700000	700000

● = Standard equipment ○ = Optional equipment – = Not available

For information about the equipment options, see pages 50 – 53.

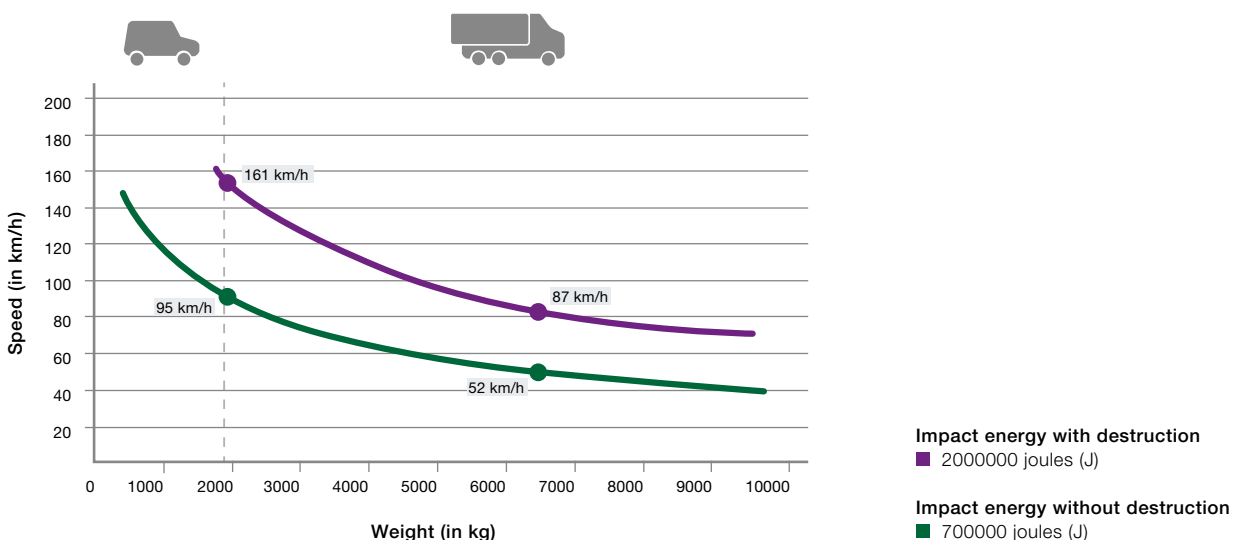



Configuration with **one fixed cylinder**

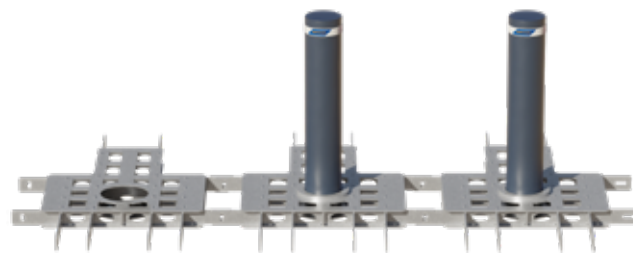

Configuration with **two fixed cylinders**

Extensions and arrangements

Modules with one or two bollards

Configuration with one bollard **1** or two bollards **2** to extend the standard configuration

Inclining or sloping arrangement

Height offsets are feasible. The number, dimensions and stepped arrangements of bollards can individually be adapted according to local conditions upon consultation

Angled arrangements **3**

Flexible, individual angled arrangements possible

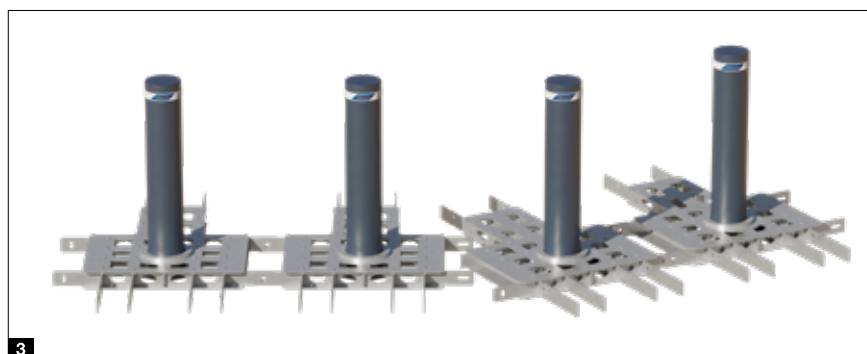
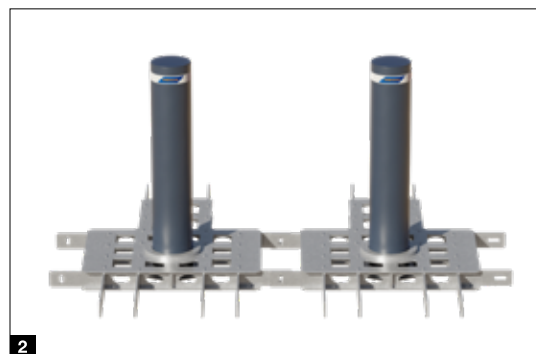

Equipment

For Security Line and High Security Line bollards

Standard equipment

Cylinder cover **1**

- ABS plastic (Security Line)
- Aluminium with anti-corrosion coating (High Security Line)

Reflecting strips **2**

- Better visibility at night
- All-round

Cylinder surface **3**

- Steel, coated in Anthracite grey RAL 7016

Automatic safety cut-out **4**

- Stops lifting of automatic bollards in case of obstacles (Security Line)
- Can be deactivated



Optional equipment

Steel surface finishes ¹

- Anti-corrosion coating
- Coating in RAL to choose

LED lighting strips ²

- Better visibility at night
- Warning light when bollard is lifted and lowered
- All-round

Additional equipment variants and options on request

*Only for fixed High Security Line bollards (except M30 SF)

** Only for bollards with exchangeable stainless steel sleeve and bollard ST

Stainless steel surfaces ³

- V2 A or V4 A
- K180 (polished)
- Coating in RAL to choose
- **NEW.** Steel with exchangeable stainless steel sleeve as an attractively priced alternative to solid material (V2 A)*

NEW. Plain bollard head** ⁴

- V2 A
- Attractively priced variant with welded cover

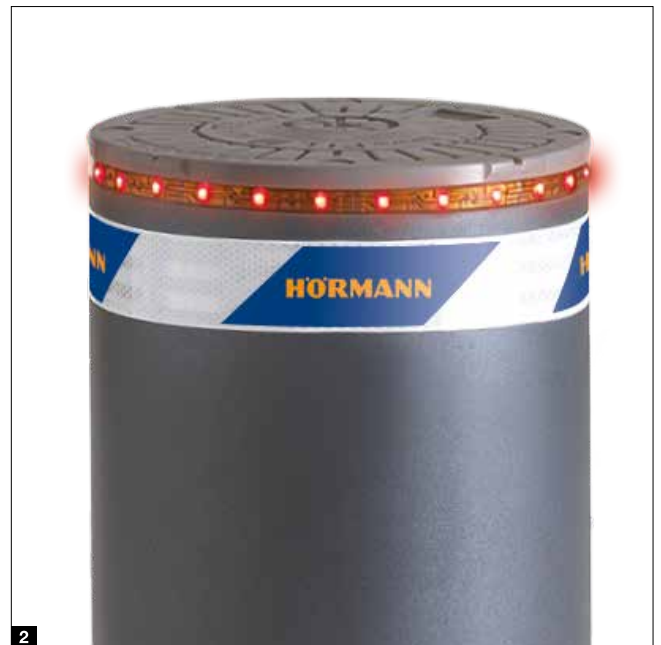

Equipment

For Security Line and High Security Line bollards

Heating element ⁵

- Reliable operation in areas at risk of snow and ice

UPS uninterruptible power supply ⁷

- To bypass power failures for up to ten cycles
- Recharges during normal operation

EFO emergency function ⁸

- Fast extension within approx. 1.5 seconds in emergency situations for automatic bollards

Individually designed cylinder cover ⁶

- Optional for bollards with stone mantle
- Design according to customer requirements



Behaviour in case of power failure ⁹

- Automatic lowering of automatic bollards
- Emergency manual operation to lift and lower

Pavement frame ¹⁰

- For laying paving stones
- For automatic and semi-automatic bollards as well as fixed bollards with bottom plate (Security Line)
- Stainless steel, coated in Anthracite grey (anti-slip)
- Optionally in brushed stainless steel

Additional equipment variants and options on request

* Except for RI version and bollards with electromechanical operator

Stone mantle ¹¹

- Available for fixed and automatic bollards with 275 mm diameter, in heights of 600 and 800 mm *
- Available in many natural stone types
- Unique design possibility due to matching appearance of fixed and automatic bollards

Acoustic warning signal ¹²

- Warning signal when lifting and lowering bollard



Road blockers

To secure passages up to 6 m wide



- For high use frequencies (approx. 2000 cycles / day)
- Road Blocker 500: barrier height 500 mm
- Road Blocker 1000: barrier height 1000 mm
- Flush-fitting in the ground
- External hydraulic operator (max. distance 30 m)
- Optionally with EFO emergency function (Emergency Fast Operation)



	Road Blocker 500	Road Blocker 1000
Ramp height above ground level (mm)	500	1000
Standard length (m)	2 / 3 / 4 / 5 / 6	2 / 3 / 4 / 5 / 6
Fitting depth (mm)	300	300
Technical data		
External hydraulic operator	●	●
Speed, lifting (cm/s)	11	14,2
Speed, lowering (cm/s)	11	14,2
EFO emergency function	○	○
Manual operation	○	○
LED lighting strips	○	○
Protective sections	●	●
Load class acc. to EN 124	D400 (40 tonnes)	D400 (40 tonnes)
Cycles (approx. per day)	2000	2000
Overall cycles (max. service life)	3000000	3000000
Certified acc. to	–	PAS68
Compliant with	M30, K4, PAS68, IWA14-1	M50, K12, IWA14-1
Impact energy with destruction (J)	750000	2000000
Temperature range	–40 °C to +70 °C*	–40 °C to +70 °C*

● = Standard equipment ○ = Optional equipment – = Not available

For information about the equipment options, see page 57.

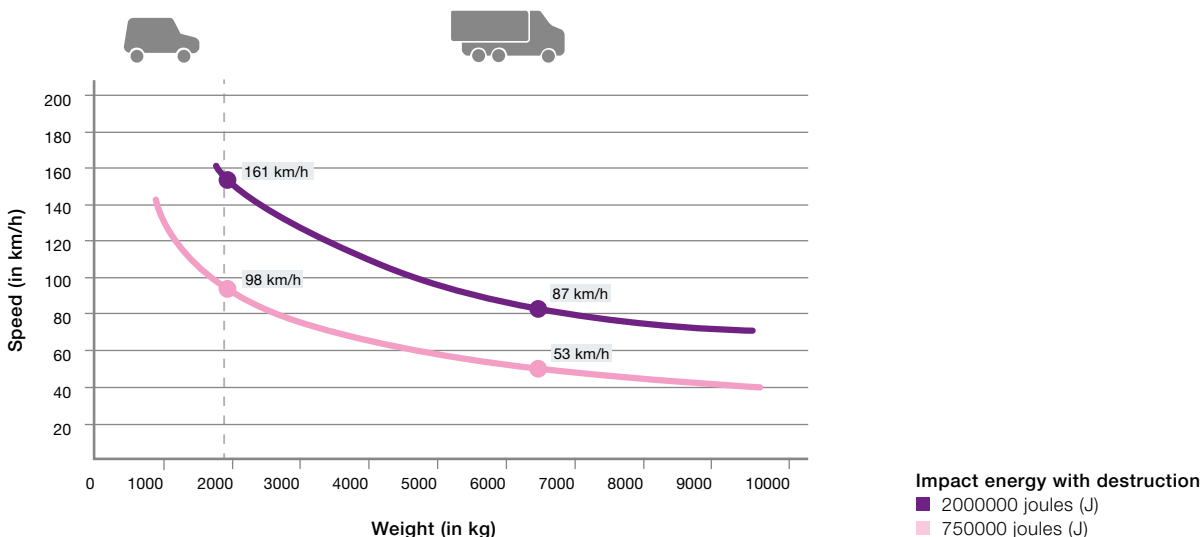



Road blockers

For fast and easy fitting on suitable ground surfaces

- For high use frequencies (approx. 2000 cycles / day)
- Road Blocker 500SF: barrier height 500 mm
- Road Blocker 1000SF: barrier height 1000 mm
- Integrated hydraulic operator
- Simple, fast fitting on the finished ground surface
- Can also be used as temporary vehicle barrier
- **NEW.** Variant with press-and-hold control
- **NEW.** Variant with manual operation by electric screwdriver



	Road Blocker 500 SF	NEW. Road Blocker 1000 SF
Height (mm)	500	1000
Standard length (m)	4 / 5 / 6	4 / 5 / 6
Passage width (m)	3.5 / 4.5 / 5.5	3.5 / 4.5 / 5.5
Fitting depth (mm)	0	0
Technical data		
Integrated hydraulic pump	●	●
Speed, lifting (cm/s)	9,1	14,2
Speed, lowering (cm/s)	7,1	14,2
Emergency operation	○	○
NEW. Variant with press-and-hold control	-	○
NEW. Variant with manual operation by electric screwdriver	-	○
EFO emergency function (only with fully automatic variant)	-	○
Manual operation (only with fully automatic and press-and-hold variants)	○	○
Photocell (only with fully automatic variant)	●	●
Warning light on two sides for passage control (only with fully automatic and press-and-hold variants)	●	●
Acoustic warning signal (only with fully automatic and press-and-hold variants)	●	●
Load class acc. to EN 124	D400	D400
Cycles (approx. per day)	2000	2000
Overall cycles (max. service life)	3000000	3000000
Certified acc. to	PAS68, IWA14-1	M30, PAS68, IWA14-1
Impact energy with destruction (J)	140000	750000
Temperature range	-40 °C to +70 °C*	-40 °C to +70 °C*

● = Standard equipment ○ = Optional equipment - = Not available

For information about the equipment options, see page 57.

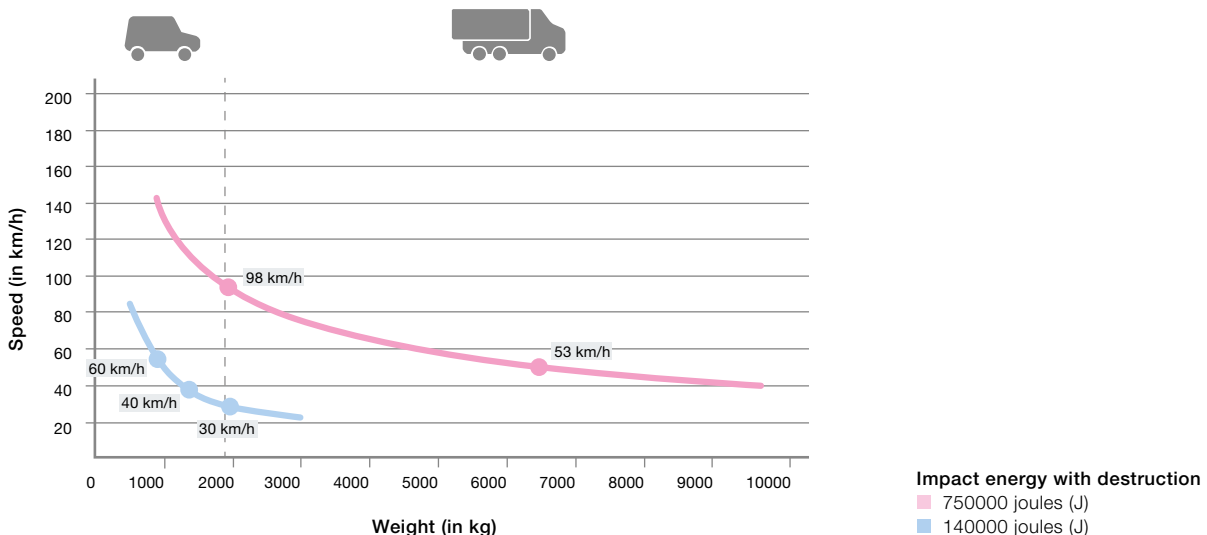

Tyre killers

To secure passages in one direction



Tyre Killer M

- For average use frequencies (approx. 100 cycles / day)
- Fitting on finished ground surface, no earthworks required
- Optional manual lowering for passage in both directions

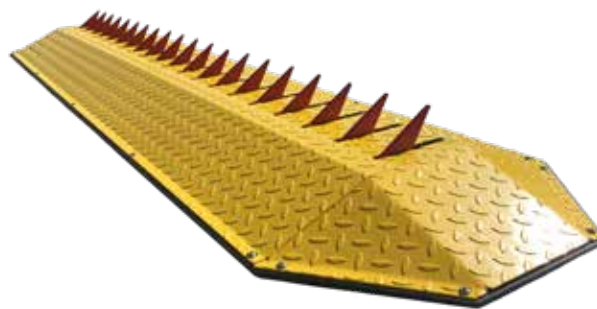

Tyre Killer H

- For high use frequencies (approx. 2000 cycles / day)
- Flush-fitting in the ground
- External hydraulic operator (max. distance 30 m)
- Optionally with EFO emergency function (Emergency Fast Operation)
- Manual lowering for passage in both directions



	Tyre Killer M	Tyre Killer H
Height of spikes above ground level (mm)	61	500
Length (m)	2 / 3 / 4 / 5 / 6	2 / 3 / 4 / 5 / 6
Spike width (mm)	10	20
Spike spacing (mm)	105	200
Fitting depth (mm)	–	710
Technical data		
Speed, lifting (cm/s)	11	11
Speed, lowering (cm/s)	11	11
Extension via counter weight	●	–
Extension by integrated hydraulic operator	–	●
Manual lowering for passage in both directions	○	●
EFO emergency function	–	○
Locking device	○	○
Load class acc. to EN 124	C250	D400
Cycles (approx. per day)	100	2000
Overall cycles (max. service life)	200000	3000000

● = Standard equipment ○ = Optional equipment – = Not available

For information about the equipment options, see page 57.

Optional equipment

For road blockers and tyre killers

LED lighting strips ¹

- Better visibility at night
- Warning light when bollard is lifted and lowered
- For road blockers

EFO emergency function ²

- Fast extension within approx. 1.5 s in emergency situations

Behaviour in case of power failure ³

- Manual emergency operation

UPS uninterruptible power supply ⁴

- To bypass power failures for up to ten cycles
- Recharges during normal operation

Acoustic warning signal ⁵

- Warning signal when lifting and lowering

Heating element ⁶

- Reliable operation in areas at risk of snow and ice
- For road blockers

Additional equipment variants and options on request

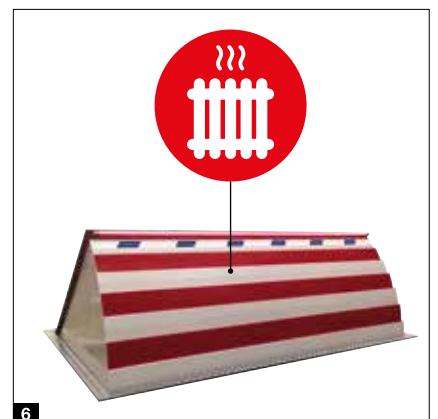
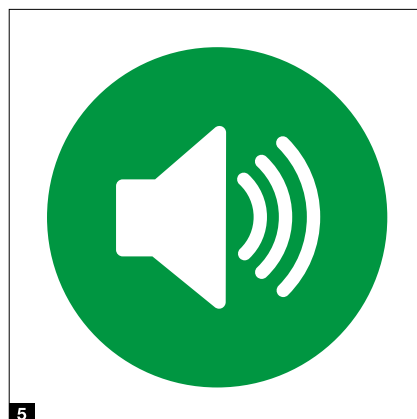
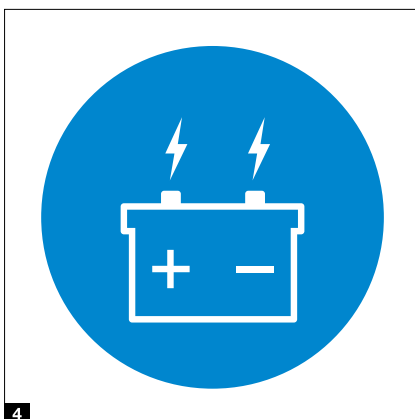

Mobile vehicle blocker

For flexible and certified safeguarding of events



The OktaBlock mobile vehicle blocker **secures driveways and access** to open-air events and effectively prevents vehicles from smashing through. The design of the Hörmann OktaBlock is inconspicuous, and is therefore not perceived to be threatening. Whether it's a city festival in springtime, a summer festival or a Christmas market in winter – mobile vehicle blockers allow different events to be secured in a location-independent and cost-efficient way at flexible times.

Certified personal safety

The vehicle blocker is certified as a single module. Therefore it is not necessary to connect multiple modules, contrary to many competitive products. This guarantees maximum flexibility and ensures escape routes.

The OktaBlock is certified according to international standards BSI PAS68:2013 and IWA-14-1:2013 standardised crash test "N2/N2A".

In this standardised crash test, an unmanned N2/N2A category lorry with a **test weight of 7.5 tonnes and a speed of 50 km/h** drives against a barrier. The resulting impact energy is 750000 joules.



The OktaBlock TR is certified according to the technical guidelines of the German police for mobile vehicle blockers. **1** In this even more stringent test, an impact at 90° as well as at 45° is carried out. In addition, the test takes place on wet roads and the vehicle may no longer be roadworthy after the impact. The maximum impact energy in this test is up to 986000 joules.

Due to its axisymmetric geometry, the Hörmann OktaBlock **has no predefined impact side and can thus prevent a vehicle collision from any direction.** In addition, the innovative vehicle blocker is tamper-proof, non-flammable and does not need to be guarded before and during the event.

Use as advertising or notice space **2**

The optional all-round banner can be optimally used as advertising media, for example, for city festivals or Christmas markets.



Space-saving transport **3**

The mobile vehicle blockers are transported in an extremely space-saving way. Due to the low stand area of the individual elements of only 800 x 800 mm, 21 modules can be transported with a standard lorry with six loading metres.

Time-saving installation

The **fully assembled individual blockers** can be positioned with a standard crane truck or forklift truck and can be quickly and easily put up and taken down on-site without special technical knowledge. The vehicle blocker can be easily moved for assembly and disassembly with a crane or forklift.



Mobile vehicle blocker

For flexible safeguarding of events

OktaBlock

- Certified as a single module according to BSI PAS68:2013 and IWA-14-1:2013 (M30 High Security)
- Version TR certified according to the technical guidelines of the German police for mobile vehicle blockers
- Modules do not have to be connected thanks to certification as a single module
- Completely assembled single blockers for easy installation without on-site structural work
- Flexible, location-independent, cost-efficient, maintenance-free
- Can be used as a notice or advertising space on request



	OktaBlock	OktaBlock TR
Base plate dimensions (mm)	800 × 800	800 × 800
Bollard height (m)	1250	1250
Base plate height, chamfered (mm)	5–33	18–43
Bollard diameter (mm)	273	273
Colour	Anthracite grey RAL 7016*	Anthracite grey RAL 7016*
Weight (in kg)	Approx. 350	Approx. 450
Technical data		
Impact energy (J)	750000	986000
Certified acc. to	M30, K4, PAS68, IWA14-1	SK1B, TR Pol**

* Optionally in RAL to choose at a surcharge

** According to the technical guidelines of the German police for mobile vehicle blockers, version 0.8

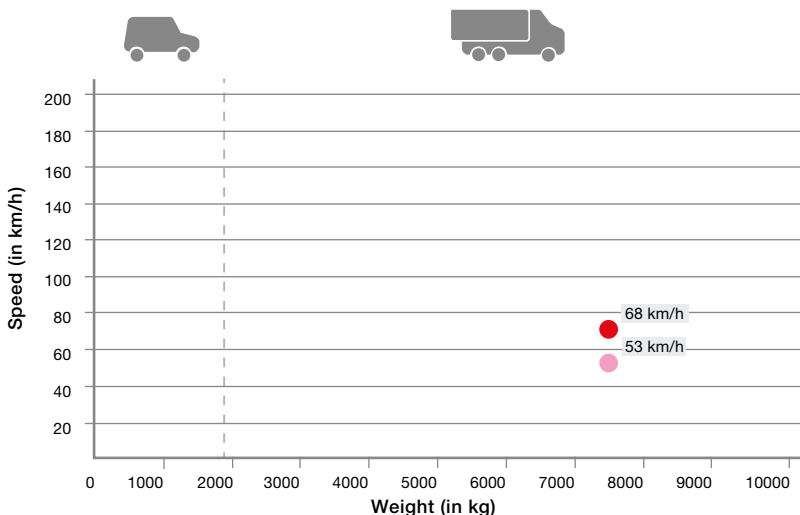

Impact energy with destruction

The values indicate at which speed and which vehicle weight a certain impact energy is generated in which the passage is prevented with destruction of the OktaBlock.

Impact energy with destruction

- 986000 joules (J)
- 750000 joules (J)

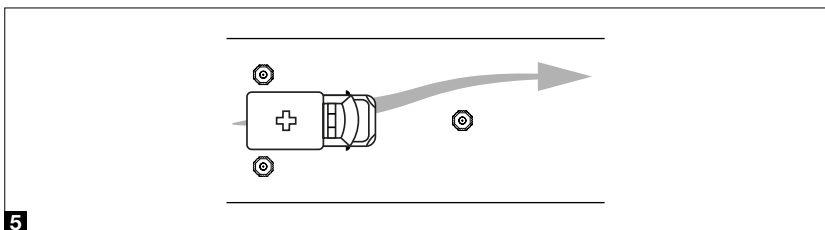
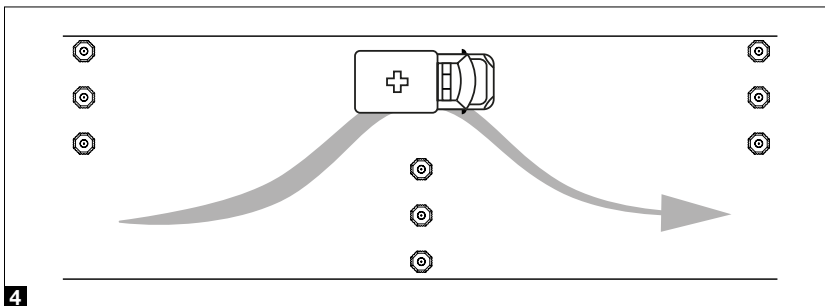
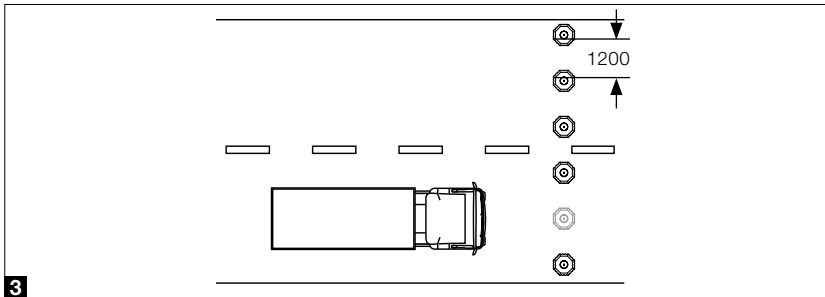
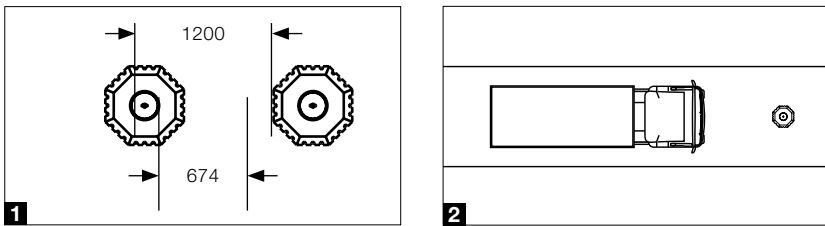

All details in mm

Arrangement variants

The OktaBlock blockers can be arranged individually, in rows or offset. As a result, individual protection concepts can be implemented that are tailored to your specific requirements.

- 1 Unobstructed escape routes at all times without impairing visibility
- 2 Blocker for narrow streets and inner cities
- 3 Blocker with unlimited width enabling the quick and easy set-up of passage points for authorised vehicles
- 4 Deflector sluice can be passed by authorised vehicles
- 5 V-slucice can be passed by authorised vehicles



Transport aid OktaMover for OktaBlock / OktaBlock TR

With the hydraulically operated transport aid OktaMover, OktaBlock bollards can be positioned and moved quickly and easily without the need for motorised special vehicles (forklift, crane) that require a special driver's licence. This makes it possible to quickly create a passage for rescue vehicles, for example, in an emergency.



Adapter for fastening construction site lights

With the universal adapter, the widely used construction site lights known from road traffic can be fastened to the head of the OktaBlock / OktaBlock TR. This ensures optimal visibility of the bollard even at night.

Hörmann Access Control HAC

Online perimeter protection and access regulation

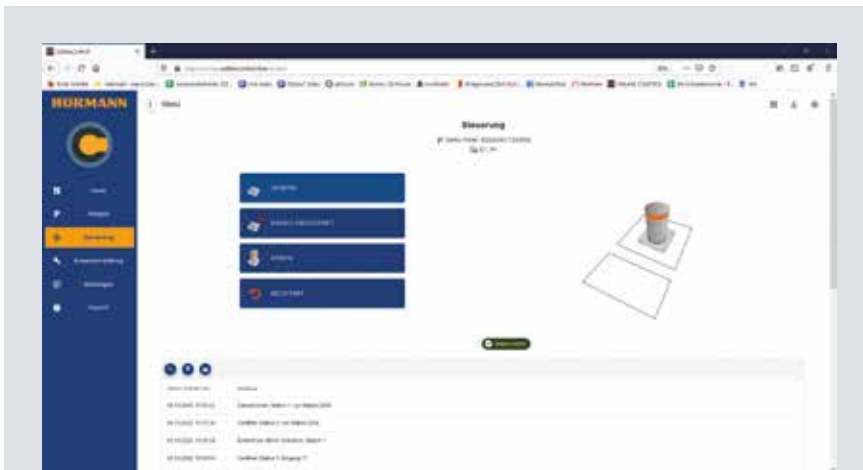

Web view in browser

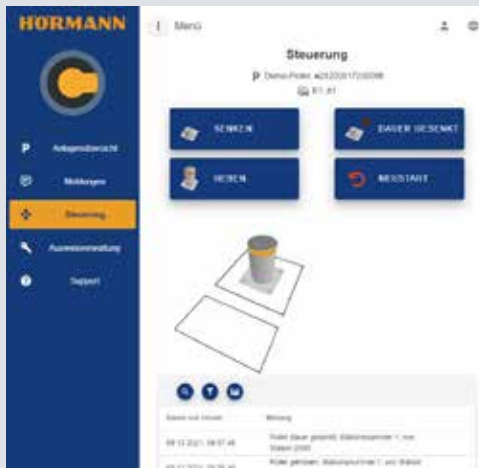

Web view on tablet

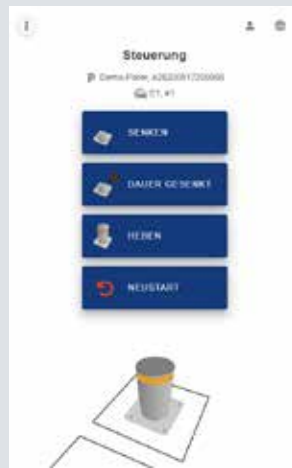

Web view on smartphone

Functions at a glance

- System developed in-house for automatic bollards
- Optional management of up to 2000 ID card media for regulating passages
- Simple operation via web browser on mobile and stationary devices
- Convenient user management incl. user groups
- Issuing individual access authorisation
- Flexible entry and exit management
- Convenient malfunction recognition
- Message memory for 100000 messages, optionally more if linked to the internet
- Ideal for combining with optional number plate recognition and long range RFID



Vehicle number plate recognition

A camera scans the number plate of the vehicle and allows entrance or exit with the correct authorisation. a separate ID medium is not required.

Key switch posts

For perimeter protection and access regulation

Key switch post, stainless steel 170

- Operation of automatic bollards directly at the bollard
- Perimeter protection using key switches, transponder key switches and code switches
- Access regulation using one-sided or two-sided traffic lights (red / green)
- To accommodate up to max. two bollard controls (only for variant that opens to the top)

Key switch post, stainless steel 275

- Operation of automatic bollards directly at the bollard
- Harmonious appearance in combination with bollards with diameters of 275 mm
- Accommodates control for up to four bollards
- Perimeter protection using key switches, transponder key switches and code switches
- Access regulation using one-sided or two-sided traffic lights (red / green)
- Maintenance flap with lock



	Key switch post, stainless steel 170	Key switch post, stainless steel 275
Diameter (mm)	170	275
Heights (mm)	1500, 1800	1500, 1800

Technical data

Fixed	●	●
Key switch post opening to the top	○	●
Mounting base	●	●
Lockable maintenance flap		●
Protection category	IP 55	IP 55

● = Standard equipment ○ = Optional equipment



1
Stainless steel surface, coated in Anthracite grey RAL 7016 (as standard), coating in RAL to choose (optional)



2
Stainless steel surface, polished finish, K240 (brushed)



3
Maintenance flap (for stainless steel key switch post 275)



4
Perimeter protection using key switches, transponder key switches and code switches



5
Access regulation using one-sided or two-sided traffic lights (red / green)

Accessories

Radio control, receiver



HS 5 BS
4 button functions
plus query button,
High-gloss surface
Black or white



HS 5 BS
4 button functions
plus query button,
textured surface
Matt black



HS 4 BS
4 button functions,
textured surface
Matt black



HS 1 BS
1 button function,
textured surface
Matt black



HSE 1 BS
1 button function,
incl. eyelet for key ring,
textured surface
Matt black



HSE 4 BS
4 button functions,
incl. eyelet for key ring,
textured surface matt black
with chrome or plastic caps



HSE 2 BS
2-button hand transmitter,
High-gloss black or white,
with chrome caps



HSS 4 BS
4-button security hand transmitter,
Additional function: copy
protection for hand transmitter
coding, with chrome caps



Only from Hörmann

Modern radio system

The bi-directional BiSecur radio system is based on future-oriented technology for convenient and secure operation. The extremely secure BiSecur encryption protocol makes sure that no one can copy your radio signal. It was tested and certified by security experts at Bochum university.

Your advantages

- 128-bit encryption with the same high security level as online banking
- Interference-resistant radio signal with a stable range
- Compatible with Hörmann door control and perimeter protection systems
- Backwards compatible, i.e. radio receivers with the frequency 868 MHz (2005 to June 2012) can also be operated with BiSecur control elements



Industrial hand transmitter HSI BS
 To control up to 1000 receivers, with a display and extra-large quick selection buttons for easier operation with work gloves, transferring of hand transmitter coding to other devices possible



Industrial hand transmitter HSI 6 BS, HSI 15 BS
 To control up to 6 / 15 receivers, with extra-large buttons for easier operation with work gloves, impact-resistant housing
 Protection category: IP 65



Radio code switch FCT 3 BS
 3 functions, with illuminated buttons, recessed or surface-mounted fitting possible, plastic housing in Light grey RAL 7040 (also available with ten functions and hinged cover, painted in White aluminium RAL 9006)



Radio code switch FCT 10 BS
 10 functions, with illuminated buttons and hinged cover, recessed or surface-mounted fitting possible, plastic housing in White aluminium RAL 9006



Radio finger-scan FFL 25 BS
 2 functions and up to 25 fingerprints, with hinged cover, recessed and surface-mounted fitting possible, plastic housing painted in White aluminium RAL 9006



2-channel relay receiver HET-E2 MCX BS
 With 2 volt-free relay outputs for choosing the direction, one 2-pin input for volt-free Open/Close limit switch reporting, external antenna



Hörmann homee Brain
 Basic cube with BiSecur radio system for operating Hörmann garage door and entrance gate operators, entrance door locks, electric devices and perimeter protection systems via the Hörmann homee app

Accessories

Code switches, finger-scans, transponder key switches



Code switches CTR 1b-1, CTR 3b-1
For one (CTR 1b-1) or three (CTR 3b-1) functions, with illuminated buttons

Dimensions:
80 × 80 × 15 mm (W × H × D)



Code switches CTV 3-1
For three functions, with particularly robust metal keypad

Dimensions:
80 × 80 × 15 mm (W × H × D)



Code switches CTP 3
For three functions, with illuminated lettering and touch-sensitive surface

Dimensions:
80 × 80 × 15 mm (W × H × D)



Decoder housing
For code switches CTR 1b-1, CTR 3b-1, CTV 3-1, CTP 3

Dimensions:
140 × 130 × 50 mm (W × H × D)
Switching capacity: 2.5 A / 30 V DC
500 W / 250 V AC



Finger-scan FL 150
For two functions, up to 150 fingerprints can be saved

Dimensions: 80 × 80 × 13 mm (W × H × D);
Decoder housing: 70 × 275 × 50 mm (W × H × D);
Switching capacity: 2.0 A / 30 V DC



Transponder key switch TTR 1000-1
For one function via transponder key or transponder card, up to 1000 keys or cards can be saved

Dimensions: 80 × 80 × 15 mm (W × H × D);
Decoder housing: 140 × 130 × 50 mm (W × H × D);
Switching capacity: 2.5 A / 30 V DC; 500 W / 250 V AC



**DI 1 induction loop
in a separate additional housing**

Suitable for one induction loop, detector with a normally open contact and a change-over contact

**DI 2 induction loop (not shown)
in a separate additional housing**

Suitable for two separate induction loops, detector with two potential-free closing contacts, can be set for impulse or permanent contact, directional recognition possible

Dimensions of additional housing:
202 × 164 × 130 mm (W × H × D);

Switching capacity:

DI 1: low voltage 2 A, 125 V A / 60 W;

DI 2: 250 V AC, 4 A, 1000 VA

(resistivity AC);

Supplied without loop cable

Loop cable for induction loop: 50 m roll,
cable designation: SIAF,
cross-section: 1.5 mm², colour: brown



**Digital weekly timer
in a separate additional housing**

The timer can switch command units on and off via a volt-free contact; extension unit for controls (for fitting in existing housing); switching capacity: 230 V AC 2.5 A / 500 W, can be switched over to summer / winter time, manual switching: automatic operation, switching preselection permanently ON / OFF

Dimensions of additional housing:
202 × 164 × 130 mm (W × H × D);

Protection category: IP 65



**Summer / winter activating kit
in additional housing**

Function for full door opening and individually programmable intermediate travel limit, extension unit for controls

Dimensions of additional housing:
202 × 164 × 130 mm (W × H × D);

Protection category: IP 65

Not for control 445/545



Key switch ESU 30 with three keys, recessed version, Impulse or Open / Close functions selectable; dimensions of switch box:

60 mm (d), 58 mm (D),

Dimensions of the cover:

90 × 100 mm (W × H),

Brickwork recess:

65 mm (d), 60 mm (D);

Protection category: IP 54

Surface-mounted version ESA 30

Dimensions:

73 × 73 × 50 mm (W × H × D)



Key switch STAP 50 with three keys, surface-mounted version, dimensions:
80 × 80 × 63 mm (W × H × D); protection category: IP 54

Key switch STUP 50 with three keys, recessed version,

Dimensions:

80 × 80 mm (W × H);

Protection category: IP 54



Traffic lights red / green

As a visual indicator of authorized or blocked passage, not in combination with stainless steel key switch posts

Dimensions:

170 × 467 × 200 mm (W × H × D);

Contact load:

250 V AC ; 2.5 A / 500 W;

Protection category: IP 65

Everything from a single source for construction and industry

Our large product range offers the right solution for any requirement. All products are optimally adjusted to work together, ensuring high functional safety. This makes us a strong, future-oriented partner for industrial and public construction projects.

**INDUSTRIAL DOORS. LOADING TECHNOLOGY. SLIDING DOORS. CONSTRUCTION PROJECT DOORS.
PERIMETER PROTECTION SYSTEMS**

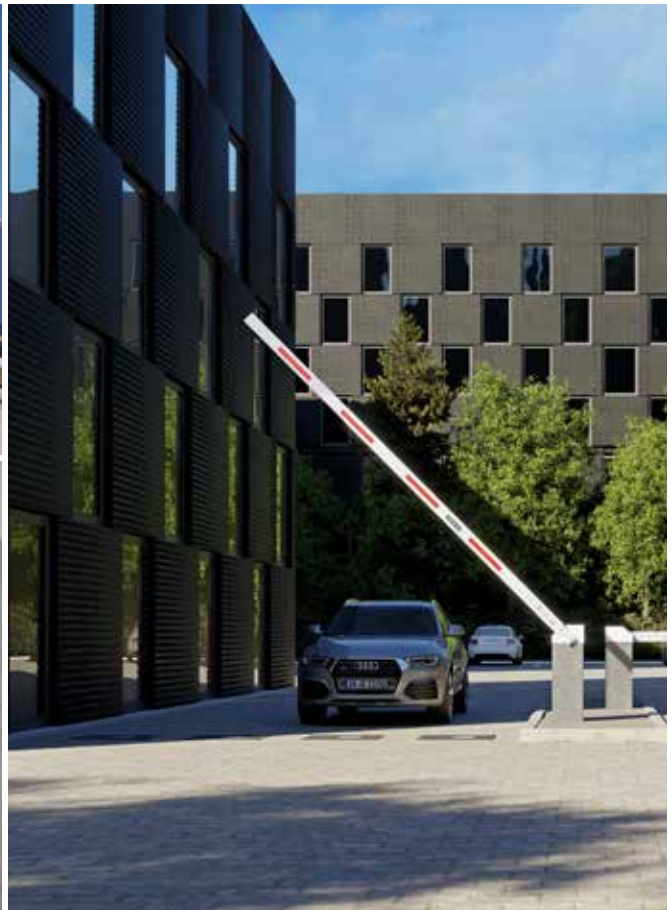

Some of the doors shown are equipped with special equipment and do not always correspond to the standard versions. The surface finishes and colours shown are subject to the limitations of the printing process and cannot be regarded as binding. All rights reserved. No part may be reproduced without our prior permission. Subject to changes.