



ALUMINIUM ENTRANCE DOORS

NEW. Classic styles for modernising older buildings

HÖRMANN





04

Good reasons
to try Hörmann
entrance doors.



14

Inspirations.



62

Design.
Equipment.
Accessories.

Responsibility for generations

The Hörmann family business has over 85 years of experience as a construction component specialist. This gives us an obligation to both past, current and future generations. That's why environmental responsibility plays such an important role for us. With this in mind, we develop innovative solutions for sustainable products and intelligent environmental protection.



“A GOOD REPUTATION MUST BE EARNED.”

August Hörmann

In keeping with the tradition started by the company's founder, the Hörmann brand is a true promise of quality and is one of Europe's most successful suppliers in the area of entrance doors. Due to the comprehensive international sales and service network, Hörmann is your strong partner for high-quality construction components.

AN EYE ON THE FUTURE. Hörmann is setting a good example. That's why 100% of our electricity needs in Germany come from green electricity. Together with an intelligent and certified energy management system, CO₂-neutral mailing and the recycling of valuable materials, more than 40000 tons of CO₂ are saved each year. In addition, we offset over 100000 tonnes of CO₂ by promoting wind energy and reforestation projects in cooperation with ClimatePartner.



You can find further information at
www.hoermann.de/umwelt



Brand quality made in Germany



The family-owned company Hörmann offers all important construction components for building and renovating projects from a single source. We manufacture in highly specialised factories using state-of-the-art production technologies. Our employees work intensively on new products, continual further developments and improvements to details. The results are patents and unique products on the market.





**10-year
warranty**

LONG-LASTING. GUARANTEED. All doors are developed and manufactured by Hörmann. Endurance tests under real conditions ensure mature series products with Hörmann quality. Thanks to this and uncompromising quality assurance, you receive a 10-year* warranty on all Hörmann aluminium entrance doors.

* The complete warranty conditions can be found at:
www.hoermann.com



**High acoustic
insulation**
Up to 34 dB

CONVINCING IN EVERY VERSION. Our aluminium entrance doors are superior to plastic or timber doors in many ways. Thanks to perfectly matched high-quality materials, we set benchmarks in terms of stability, acoustic insulation and thermal insulation.



**Excellent thermal
insulation**

In addition, all of our aluminium entrance doors meet the requirements of the new German Buildings Energy Act (Gebäudeenergiegesetz, GEG). ThermoCarbon entrance doors are also certified for low-energy houses by ift Rosenheim.



Only from Hörmann

ThermoCarbon with a UD-value
of up to 0.47 W/(m²·K)

→ For further information, see from page 14.



Easy to fit

FAST AND CLEAN FITTING. Our elegant, robust aluminium entrance doors with RC 3 security equipment are fitted professionally using pre-drilled fitting points, as with standard entrance doors of other manufacturers without RC equipment. Additional or special fixing material is not necessary, despite the certified high security equipment. Besides transport protection, the threshold with protective tube also provides a reliable floor recess. Thanks to prepared cables, electrical components are easily connected via plug-in connections.

Door design for the highest demands

Greet your guests with a Hörmann aluminium entrance door! And of course, you and your family can also delight in the sophisticated design of our doors day after day. Our doors are a true eye-catcher on the outside, and inside they harmonise perfectly with your residential internal doors. Simply beautiful!





DOOR LEAF WITHOUT VISIBLE LEAF PROFILE.

Our ThermoSafe, ThermoSafe Hybrid, ThermoPlan Hybrid and ThermoCarbon entrance doors give you an exquisite and elegant reception. The shapely door leaf with its solid interior and exterior and leaf profile on the inside fulfils the highest design requirements. The interior view harmonises perfectly with your residential internal doors.

TOP. Exterior and interior view of ThermoSafe entrance doors without visible leaf profile

BOTTOM. Exterior and interior view of entrance doors from other manufacturers with visible leaf profile

PAGE 8. Aluminium entrance door ThermoSafe style 860, stainless steel handle HOE 710, door height 2500 mm, Anthracite grey RAL 7016, optional side elements

We protect you from unwanted visitors

An apartment is broken into every five minutes, making it even more important to equip your entrance door with a high security standard. If a burglar is not successful within approx. 90 seconds, they generally give up their break-in attempt. For this reason, nearly half of all break-in attempts fail if the entrance door is break-in-resistant.





Only from Hörmann



RC 3 security
As standard



Tested and certified

Only from Hörmann



SECURITY EQUIPMENT AS STANDARD. Our entrance doors make it especially difficult for burglars to break into your home. This protects your home from break-in attempts. Additionally, the certified security features are not visible on the door, unlike with many competitor solutions.

→ For further information, see from page 70.

10-YEAR SECURITY PROMISE. In the unlikely event of a break-in through one of our aluminium entrance doors with RC 3 or RC 4 security equipment, you will receive a new Hörmann entrance door with the same equipment, including professional fitting by a **Hörmann partner**, or **€3000 cash (for example if the damage is covered by your household insurance)**.



You can find further information and a video on the topic at www.hoermann.de/sicherheitsversprechen

Choose the entrance door that matches your lifestyle

This is where individuality comes into play: No matter what your priorities are when it comes to your entrance door, at Hörmann you will find an entrance door tailored to your needs – from elegant door appearances to extensive glazings all the way to intelligent operation. Be inspired by the Hörmann variety on the following pages or configure your desired door conveniently on the internet.



THE DOOR OF YOUR CHOICE IN JUST A FEW CLICKS.

With the door configurator, you can conveniently test many design and product variations on your own PC or tablet in advance. You can put your dream entrance door together in just a few clicks by selecting the door version, style, colour and size and also see the recommended retail price of your configuration. If you then upload a picture of your house and place the door in your entrance, you can see in advance how well your new entrance door will match your home.



The Hörmann configurator can be found at:
www.hoermann.de/konfigurator







16

Design overview

22

ThermoSafe

22

ThermoSafe Hybrid

42

ThermoPlan Hybrid

46

ThermoCarbon

52

TopComfort

56

Individualisation

THERMOSAFE / THERMOSAFE HYBRID



Style 40
Page 37



Style 45
Page 37



Style 65
Page 31



Style 75
Page 31



Style 110
Page 32



Style 136
Page 32



Style 138
Page 32



Style 140
Page 32



Style 413
Page 39



Style 414
Page 39
■ NEW



Style 416
Page 39
■ NEW



Style 419
Page 41
■ NEW



Style 420
Page 41
■ NEW



Style 421
Page 41
■ NEW



Style 422*
Page 41
■ NEW



Style 445
Page 39



Style 501
Page 34



Style 502
Page 34



Style 503
Page 33



Style 504
Page 31



Style 505
Page 37



Style 514
Page 34



Style 524
Page 34



Style 551
Page 24



Style 675
Page 39



Style 680
Page 31



Style 686
Page 33



Style 689
Page 31



Style 693
Page 28



Style 694
Page 39



Style 697
Page 31



Style 723
Page 33



Style 836
Page 24



Style 860
Page 24



Style 861
Page 28



Style 862
Page 28



Style 867
Page 31



Style 871
Page 29



Style 872
Page 29



Style 877
Page 33

→ For further information, see from page 22.



Style 166
Page 32



Style 173
Page 29



Style 176
Page 34



Style 177
Page 34



Style 185
Page 33



Style 188
Page 28



Style 189
Page 33



Style 402
Page 39



Style 451
Page 40
■ NEW



Style 452
Page 40
■ NEW



Style 453
Page 40
■ NEW



Style 454*
Page 41
■ NEW



Style 455
Page 40
■ NEW



Style 456
Page 40
■ NEW



Style 457
Page 40
■ NEW



Style 459*
Page 41
■ NEW



Style 552
Page 37



Style 553*
Page 37

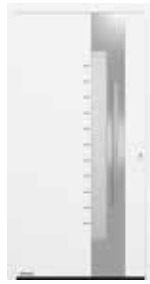

Style 560
Page 32



Style 565
Page 24



Style 568
Page 24



Style 583
Page 37



Style 590*
Page 37



Style 650
Page 31



Style 757
Page 35



Style 759
Page 35



Style 777
Page 35



Style 779
Page 35



Style 797
Page 35



Style 799
Page 35



Style 823
Page 24



Style 832
Page 24



Styles
825 / 845 / 855
Page 27



Styles
875 / 895 / 898
Page 27



Style 879
Page 33



Style 891*
Page 24

* Not available as ThermoSafe Hybrid

THERMOPLAN HYBRID



Style 138
Page 44



Style 189
Page 44



Style 501
Page 44



Style 502
Page 44



Style 503
Page 44



Style 504
Page 44



Style 505
Page 44



Style 686
Page 45



Style 689
Page 45



Style 823
Page 45



Style 860
Page 45



Style 862
Page 45



Style 867
Page 45



Style 871
Page 45



Style 872
Page 45

→ For further information,
see from page 42.

THERMOCARBON



Style 189
Page 48



Style 300
Page 48



Style 301
Page 48



Style 304
Page 48



Style 305
Page 48



Style 306
Page 49



Style 309
Page 49



Style 310
Page 49



Style 312
Page 49



Style 504
Page 49



Style 565
Page 51



Style 568
Page 51



Style 680
Page 51



Style 686
Page 51



Style 823
Page 51

→ For further information,
see from page 46.

TOPCOMFORT



Style 302
Page 48



Style 862
Page 51



Style 100
Page 54



Style 101
Page 54



Style 308
Page 49



Style 100
MG 111
Page 54



Style 100
MG 112
Page 55



Style 314
Page 49



Style 100
MG 113
Page 55



Style 100
MG 114
Page 55



Style 650
Page 51



Style 100
MG 115
Page 55



Style 100
MG 116
Page 55



Style 860
Page 51



Style 100
MG 117
Page 55

→ For further information,
see from page 52.







ThermoSafe

ThermoSafe Hybrid



Flush-fitting transition
on the inside



RC 3 security
As standard for all ThermoSafe doors and all ThermoSafe Hybrid doors with glazing



RC 4 security
As standard for all ThermoSafe Hybrid doors without glazing



High acoustic insulation
Up to 34 dB (ThermoSafe)
Up to 36 dB (ThermoSafe Hybrid)



Very good thermal insulation
 U_D -value of up to 0.87 W/(m²·K)



Door leaf exterior made of stainless steel
ThermoSafe Hybrid

EXCLUSIVE CLASS. Our best-selling aluminium entrance door ThermoSafe meets the highest of design standards with a choice of over 75 styles. The transition from the door leaf to the door frame gives your doors an elegant interior look in perfect harmony with flush-closing residential internal doors.

TOP CLASS. Made of powder-coated stainless steel sheet, the exterior of the ThermoSafe Hybrid door leaf guarantees particularly high dimensional stability, even in case of large temperature differences inside and outside.

Solid door view on the outside **1** and inside **2** as well as a flush-fitting transition from the door leaf to the door frame on the inside



PAGE 20 – 21 AND LEFT. Aluminium entrance door ThermoSafe style 871, stainless steel handle HOE 501 in Jet black RAL 9005, outside Grey aluminium RAL 9007, inside Traffic white RAL 9016, optional concealed hinges, optional side elements



Style 860

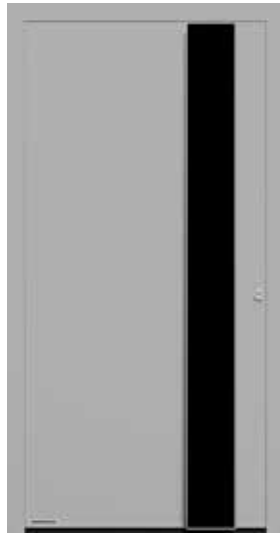

Style 565



Style 568

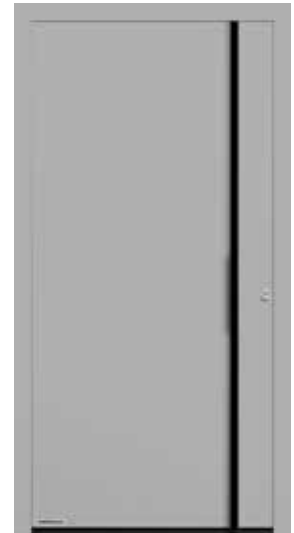

Style 823



Style 551

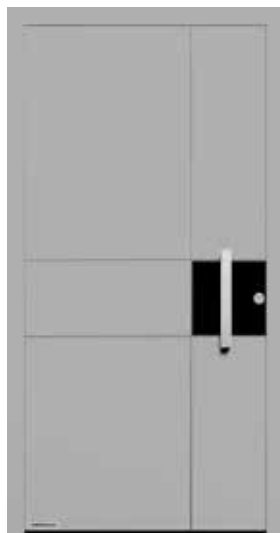

Style 832

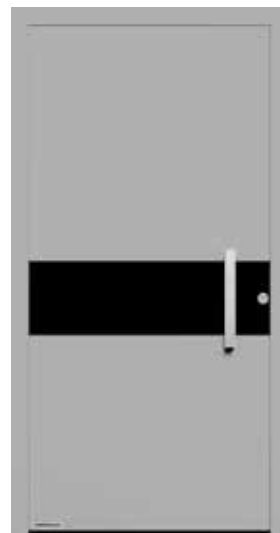

Style 836

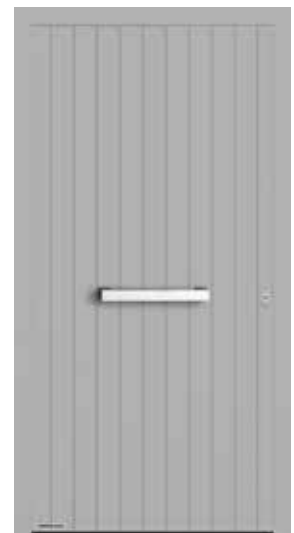

Style 891

THERMOSAFE / THERMOSAFE HYBRID

All door styles on this page in White aluminium, RAL 9006, silk-gloss

Style 860 stainless steel handle HOE 501 black.edition in Jet black RAL 9005 (optional)

Style 565 design handle G 760 black.edition in Jet black RAL 9005 (optional) **1**, optionally with integrated LED light strip

Style 568 design handle G 750 black.edition in Jet black RAL 9005 (optional) **2**, optionally with integrated LED light strip

Style 823 handle profile black.edition in Jet black RAL 9005 (optional), fixing profiles in door colour, optionally with LED spotlight in the handle **3**

Style 551 hand-crafted stainless steel handle HOE 150

Style 832 stainless steel handle HOE 820, embellishment in Jet black RAL 9005 (optional), with horizontal and vertical stainless steel pilaster strips

Style 836 stainless steel handle HOE 820 **4**, flush-fitting embellishment in Jet black RAL 9005 (optional)

Style 891* stainless steel handle HOE 820

* Not available as ThermoSafe Hybrid

→ You will find all colours and surface finishes on page 78.





Only from Hörmann

PERFECTLY MATCHING ENTRANCE DOOR AND GARAGE DOOR.

The extensive Hörmann range with matching products provides you with aligned entrance door and garage door ribbing options for a matching appearance.

The result: no offset from the base line. You will see: The beauty of your home is reflected in these small but crucial details.

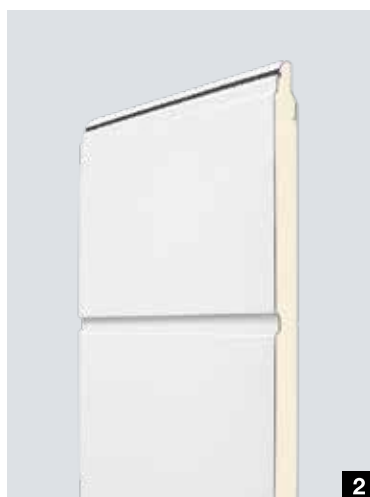

The cross-section of the entrance **1** and garage door **2** clearly shows the ribbed look of the entrance door is a result of the grooves in the infill. In the garage door, it comes from the ribbing of the individual sections and the section transitions. The aligned appearance also applies if the entrance door has a different installation height than the garage door. We can adjust the groove heights individually according to your specifications, all we need is the height offset. After precise measurement on-site, your Hörmann specialist dealer will advise you on the ideal overall look based on these entrance door styles.



Style 825 / 845 / 855



Sectional garage door
M-ribbed Silkgrain, Traffic white RAL 9016



Style 875 / 895 / 898

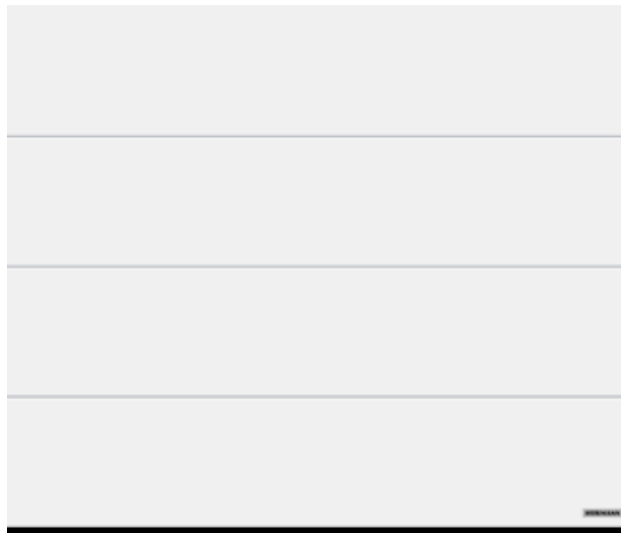

Sectional garage door
L-ribbed Silkgrain, Traffic white RAL 9016

THERMOSAFE / THERMOSAFE HYBRID

All door styles on this page in Traffic white, RAL 9016, matt

Style 825 with a door height of 2000 mm

Style 845 with a door height of 2125 mm

Style 855 with a door height of 2250 mm

Style 875 with a door height of 2000 mm

Style 895 with a door height of 2125 mm

Style 898 with a door height of 2250 mm

→ You will find all colours and surface finishes on page 78.



For more detailed information on the garage doors, please see the "Sectional garage doors" brochure.



Style 188



Sectional garage door
L-ribbed design style 457 in Silkgrain Anthracite grey RAL 7016



Style 693



Style 861



Sectional garage door
M-ribbed, Silkgrain Anthracite grey RAL 7016



Style 862

MATCHING ENTRANCE AND GARAGE DOORS.

With matching design elements and styles, your entrance doors become an attractive eye-catcher combined with garage sectional doors. In these styles, the groove spacing of the entrance door and the ribbing spacing of the garage door are not completely flush.



Style 871



Style 173

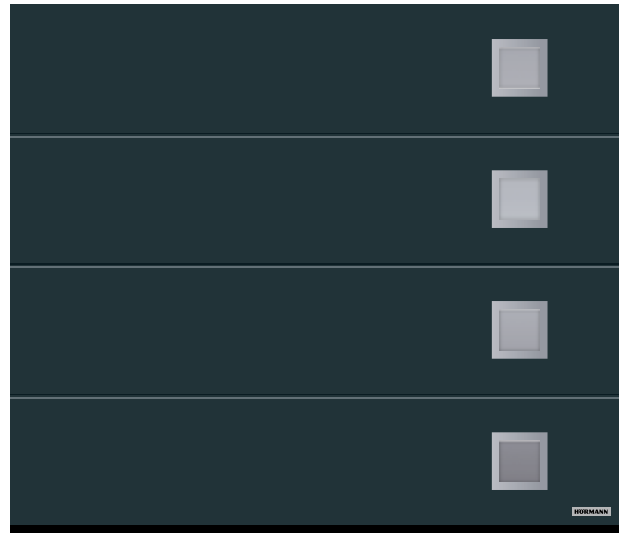

Sectional garage door

L-ribbed design style 461 in Silkgrain Anthracite grey RAL 7016



Style 872

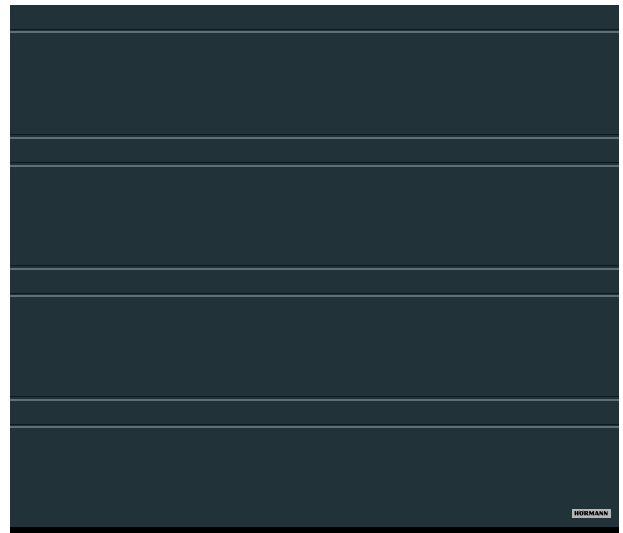

Sectional garage door

D-ribbed in Silkgrain Anthracite grey RAL 7016

THERMOSAFE / THERMOSAFE HYBRID

All door styles on this double-page spread in Anthracite grey RAL 7016

Style 188 stainless steel handle HOE 100, matt Float design glass with 3 clear stripes

Style 693 stainless steel handle HOE 300

Style 871 stainless steel handle HOE 620

Style 173 stainless steel handle HOE 300, optional matt Float ornamental glass

Style 861 stainless steel handle HOE 700

Style 862 stainless steel handle HOE 620

Style 872 stainless steel handle HOE 615, side elements with matt Float design glass with 6 clear stripes

→ You will find all colours and surface finishes on page 78.





Style 75



Style 65



Style 504



Style 650

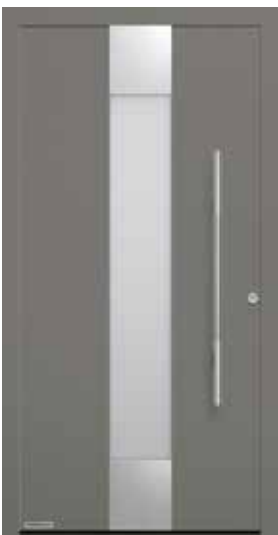

Style 680



Style 689



Style 697



Style 867

THERMOSAFE / THERMOSAFE HYBRID

All door styles on this page in Grey aluminium RAL 9007, fine structure matt

Style 75 stainless steel handle 38-1, Master-Carré ornamental glass

Style 65 stainless steel handle HOE 600, matt Float design glass with 7 clear stripes

Style 504 stainless steel handle HOE 500, matt Float design glass with 5 clear horizontal stripes

Style 650 stainless steel handle HOE 700, Pave white ornamental glass

Style 680 stainless steel handle HOE 700, Pave white ornamental glass

Style 689 stainless steel handle 38-2, matt Parsol grey design glass with 7 clear stripes

Style 697 stainless steel handle HOE 910, matt Parsol grey design glass with 7 clear stripes

Style 867 stainless steel handle HOE 620, matt Float design glass with 7 clear stripes

→ You will find all colours and surface finishes on page 78.

LEFT. Aluminium entrance door ThermoSafe style 504, stainless steel handle HOE 500, Grey aluminium RAL 9007, fine structure matt



Style 110



Style 138



Style 136



Style 140



Style 166



Style 560

THERMOSAFE / THERMOSAFE HYBRID

All door styles on this page in Hörmann colour CH 703 Anthracite

Style 110 stainless steel handle 38-1, Cathedral white ornamental glass (optional)

Style 138 stainless steel handle HOE 500, Satinato ornamental glass

Style 136 stainless steel handle 38-1, Satinato design glass with 7 matt stripes, side elements with Satinato ornamental glass

Style 140 stainless steel handle 38-1, stainless steel embellishment, Pave white ornamental glass

Style 166 stainless steel handle 38-1, stainless steel embellishment, Satinato design glass with 7 matt stripes

Style 560 stainless steel handle HOE 600, matt design glass with 11 stripes, side elements with design glass

→ You will find all colours and surface finishes on page 78.



Style 723



Style 189



Style 686



Style 185



Style 503



Style 877



Style 879

THERMOSAFE / THERMOSAFE HYBRID

All door styles on this page in Light grey, RAL 7035, matt

Style 723 handle profile in White aluminium RAL 9006, fixing profiles in door colour, Satinato ornamental glass

Style 189 stainless steel handle HOE 615, matt Float design glass with 7 clear stripes

Style 686 stainless steel handle HOE 600, stainless steel embellishment, matt Float design glass with 7 clear stripes, side elements with design glass

Style 185 stainless steel handle 38-2, white Master-Carré ornamental glass

Style 503 stainless steel handle HOE 500, matt Float design glass with 7 clear horizontal stripes

Style 877 stainless steel handle HOE 610, matt Float design glass with 3 clear stripes

Style 879 design handle G 750 in anodised aluminium E6 / EV 1, matt Float design glass with 3 clear stripes

→ You will find all colours and surface finishes on page 78.



Style 176



Style 177



Style 501



Style 502



Style 514

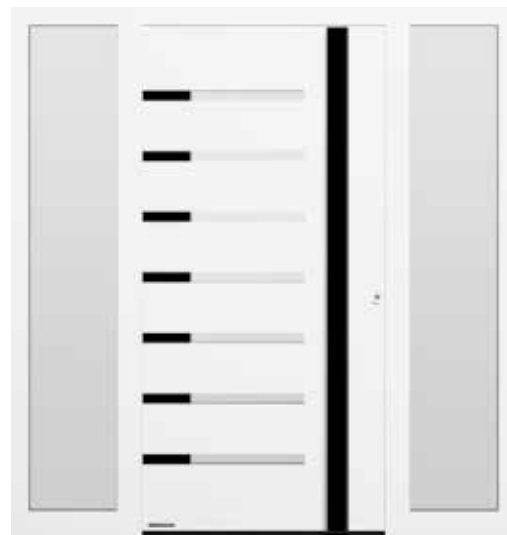

Style 524

THERMOSAFE / THERMOSAFE HYBRID

All door styles on this page in Traffic white, RAL 9016, matt

Style 176 stainless steel handle HOE 735, Satinato ornamental glass

Style 177 stainless steel handle HOE 700, Pave white ornamental glass

Style 501 stainless steel handle HOE 500, Satinato glazing

Style 502 stainless steel handle HOE 500, Satinato glazing

Style 514 design handle G 750 in White aluminium RAL 9006, silk-gloss, clear Float glazing, side elements matt design glass with 3 clear stripes

Style 524 design handle G 750 and embellishments in Jet black RAL 9005 (optional), clear Float glazing, side elements clear float glazing

→ You will find all colours and surface finishes on page 78.



Style 757



Style 759



Style 777



Style 779



Style 797



Style 799

THERMOSAFE / THERMOSAFE HYBRID

All door styles on this page in Quartz grey RAL 7039, fine structure matt

Style 757 stainless steel handle HOE 797, matt Float design glass with clear stripes

Style 759 design handle G 750 in anodised aluminium, E6 / EV 1, float design glass, matt with clear stripes

Style 777 stainless steel handle HOE 610, matt Float ornamental glass

Style 779 design handle G 750 in anodised aluminium E6 / EV 1, matt Float ornamental glass

Style 797 stainless steel handle HOE 797, matt Float ornamental glass

Style 799 design handle G 750 in anodised aluminium E6 / EV 1, matt Float ornamental glass

→ You will find all colours and surface finishes on page 78.





Style 40



Style 45



Style 505



Style 552



Style 553



Style 583



Style 590

THERMOSAFE / THERMOSAFE HYBRID

All door styles on this page in Traffic white, RAL 9016, matt

Style 40 stainless steel handle HOE 550, partially matt design glass

Style 45 stainless steel handle HOE 200, matt Parsol grey design glass with 4 clear stripes

Style 505 stainless steel handle HOE 500, matt Float design glass with 4 clear stripes

Style 552 hand-crafted stainless steel handle HOE 150, matt Float design glass with clear stripes and red colour stripes

Style 553 aluminium handle G 753 in silver, matt Reflo design glass with genuine fluted glass

Style 583 colour embellishment in Slate grey RAL 7015, aluminium handle G 755, matt Reflo design glass with clear edge

Style 590* colour embellishment in Slate grey RAL 7015, design handle G 750, Reflo design glass with genuine fluted glass and sand-blasted design

* Not available as ThermoSafe Hybrid

→ You will find all colours and surface finishes on page 78.

LEFT. Aluminium entrance door ThermoSafe style 553, Traffic white RAL 9016



STYLISH INSIDE AND OUT.

On request, the inside of our classic designs is available in a door view matching the outside. Your entrance door harmonises perfectly with classic residential internal doors in your home.

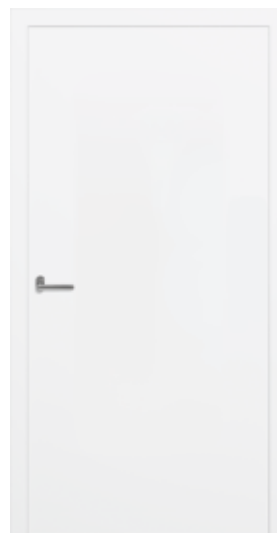

Interior view with smooth door leaf as standard



Optional interior view with ornamental frame for styles without glazing



Style 402



Style 413



Style 414 ■ NEW



Style 416 ■ NEW



Style 445



Style 675



Style 694

THERMOSAFE / THERMOSAFE HYBRID

All door styles on this page in Traffic white, RAL 9016, matt

Style 402 stainless steel handle 14-2, ornamental frame, partially matt Reflo design glass with genuine fluted glass

Style 413 stainless steel handle 14-2, ornamental frame, Silk ornamental glass

Style 414 stainless steel handle 14-2, ornamental frame, Silk ornamental glass

Style 416 stainless steel handle 14-2, ornamental frame

Style 445 stainless steel handle 38-1, ornamental frame, Chinchilla ornamental glass, side elements with Chinchilla ornamental glass

Style 675 stainless steel handle 38-1, ornamental frame, Reflo design glass with genuine fluted glass

Style 694 stainless steel handle HOE 700, ornamental frame, Reflo design glass with genuine fluted glass

→ You will find all colours and surface finishes on page 78.

TOP LEFT. Aluminium entrance door ThermoSafe style 421,
Light grey RAL 7035



Style 453 ■ NEW



Style 451 ■ NEW



Style 452 ■ NEW



TOP. Detailed view of ornamental frame with design glass



Style 455 ■ NEW



Style 456 ■ NEW



Style 457 ■ NEW

THERMOSAFE / THERMOSAFE HYBRID

All door styles on this page in Stone grey RAL 7030, fine structure matt

Style 453 stainless steel handle 14-2, ornamental frame

Style 451 stainless steel handle 14-2, ornamental frame, sand-blasted Reflo design glass with non-matt edge

Style 452 stainless steel handle 14-2, ornamental frame, sand-blasted Reflo design glass with non-matt edge

Style 455 stainless steel handle 14-2, ornamental frame, sand-blasted Reflo design glass with non-matt edge

Style 456 stainless steel handle 14-2, ornamental frame, sand-blasted Reflo design glass with non-matt edge

Style 457 stainless steel handle 14-2, ornamental frame, side elements Satinato ornamental glass

→ You will find all colours and surface finishes on page 78.



Style 421 ■ NEW



Style 419 ■ NEW



Style 420 ■ NEW



TOP. Leaded ornamental design glass with sand-blasted Reflo base glass



Style 459 ■ NEW



Style 422 ■ NEW



Style 454 ■ NEW



TOP. Detailed view of the milled grooves and of the design glass with non-matt edge

THERMOSAFE / THERMOSAFE HYBRID

All door styles on this page in Traffic white, RAL 9016, matt

Style 419 stainless steel handle 14-2, ornamental frame, leaded ornamental design glass with sand-blasted Reflo base glass (optional)

Style 420 stainless steel handle 14-2, ornamental frame, sand-blasted Reflo design glass with non-matt edge

Style 421 stainless steel handle 14-2

Style 422* stainless steel handle 14-2, milled grooves, sand-blasted Reflo design glass with non-matt edge

Style 454* stainless steel handle 14-2, milled grooves, sand-blasted Reflo design glass with non-matt edge

Style 459* stainless steel handle 14-2, milled grooves, solid style

* Not available as ThermoSafe Hybrid

→ You will find all colours and surface finishes on page 78.



ThermoPlan Hybrid



Flush-fitting transition
on the interior and exterior



RC 3 security
As standard



High acoustic insulation
Up to 36 dB



Very good thermal insulation
 U_D -value of up to 0.78 W/(m²·K)



Door leaf exterior made of stainless steel

DESIGN CLASS. What's special about this door is its elegant, flush appearance. You will not be able to see and feel any offset on the inside and outside between the door leaf and door frame.

The **STAINLESS STEEL SHEET** on the outside guarantees particularly high dimensional stability, even in case of large temperature differences, allowing you to enjoy the flush look of your entrance door for the long-term.

Solid door view and flush-fitting transition from the door leaf to the door frame on the outside **1** and inside **2**

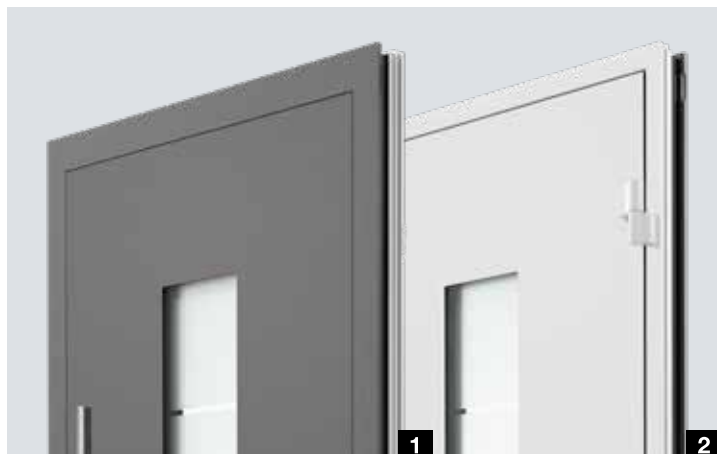

LEFT. Aluminium entrance door ThermoPlan Hybrid style 860, Hörmann colour CH 703 Anthracite, fine structure matt



Style 138



Style 189



Style 501



Style 502



Style 503



Style 504



Style 505

THERMOPLAN HYBRID

All door styles on this page in Anthracite grey RAL 7016, fine structure matt

Style 138 stainless steel handle HOE 500, Satinato ornamental glass

Style 189 stainless steel handle HOE 615, matt Float design glass with 7 clear stripes

Style 501 stainless steel handle HOE 500, Satinato glazing

Style 502 stainless steel handle HOE 500, Satinato glazing

Style 503 stainless steel handle HOE 500, matt Float design glass with 7 clear stripes

Style 504 stainless steel handle HOE 500, matt Float design glass with 5 clear stripes

Style 505 stainless steel handle HOE 500, matt Float design glass with 4 clear stripes

→ You will find all colours and surface finishes on page 78.



Style 686



Style 689



Style 823



Style 860



Style 862



Style 867



Style 871



Style 872

THERMOPLAN HYBRID

All door styles on this page in Traffic white, RAL 9016, matt

Style 686 stainless steel handle HOE 600, stainless steel embellishment, matt Float design glass with 7 clear stripes

Style 689 stainless steel handle 38-2, matt Parsol grey design glass with 7 clear stripes

Style 823 handle profile in White aluminium RAL 9006, fixing profiles in door colour

Style 860 stainless steel handle HOE 700

Style 862 stainless steel handle HOE 620

Style 867 stainless steel handle HOE 620, matt Float design glass with 7 clear stripes

Style 871 stainless steel handle HOE 620

Style 872 stainless steel handle HOE 615

→ You will find all colours and surface finishes on page 78.



ThermoCarbon



Thick rebate version
on the inside



RC 3 security
As standard



RC 4 security
Optional



High acoustic insulation
Up to 35 dB



Excellent thermal insulation

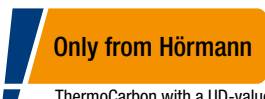

Only from Hörmann

ThermoCarbon with a UD-value
of up to 0.47 W/(m²·K)

PREMIUM CLASS. With the 100 mm thick high-tech leaf profile made of a carbon-fibreglass hybrid material, we can realise entrance doors with heights of up to 3000 mm. The many styles of flush-fitting door handles meet the highest of design standards. With a subtle thick rebate, the inside of the door blends perfectly with your interior design.

Style 308 with flush-fitting exterior handle

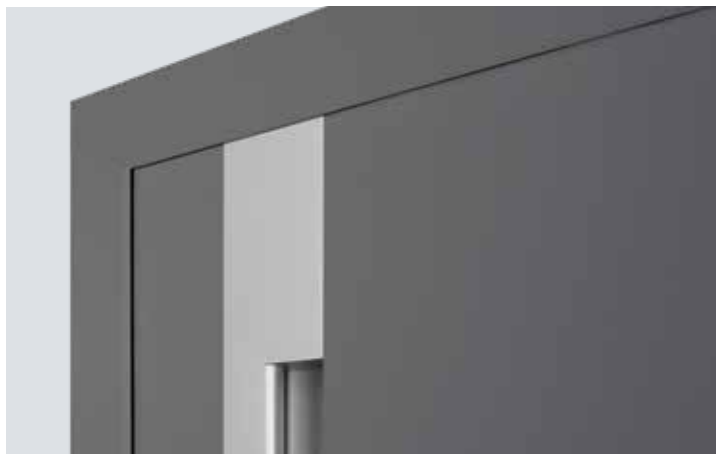

LEFT. Aluminium entrance door
ThermoCarbon style 308,
Anthracite grey RAL 7016,
door height 3000 mm

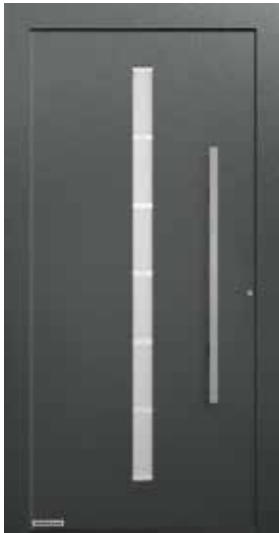

Style 189



Style 300



Style 301



Style 302



Style 304



Style 305

THERMOCARBON

All door styles on this page in Hörmann colour CH 703 Anthracite, fine structure matt

Style 189 stainless steel handle HOE 615, matt Float design glass with 7 clear stripes

Style 300 handle bar in White aluminium RAL 9006, silk-gloss

Style 301 flush-fitting aluminium embellishment and handle bar in White aluminium RAL 9006, side elements with matt Float ornamental glass

Style 302 flush-fitting handle bar in White aluminium RAL 9006, silk-gloss, matt Float design glass with a clear, vertical stripe

Style 304 recessed grip in White aluminium RAL 9006, silk-gloss, flush-fitting stainless steel handle

Style 305 aluminium embellishment in Ruby red RAL 3003, matt, flush-fitting stainless steel handle, side elements with Micrograin ornamental glass

→ You will find all colours and surface finishes on page 78.



Style 306



Style 308



Style 309



Style 310



Style 312



Style 314



Style 504

THERMOCARBON

All door styles on this page in Traffic white, RAL 9016, matt

Style 306 recessed grip in Traffic white RAL 9016, matt, flush-fitting stainless steel handle, matt Float ornamental glass

Style 308 handle bar and recessed grip in Anthracite grey RAL 7016, matt, side elements with matt Float ornamental glass

Style 309 flush-fitting handle bar in White aluminium RAL 9006, silk-gloss

Style 310 flush-fitting stainless steel handle, matt Float ornamental glass

Style 312 flush-fitting handle bar in White aluminium RAL 9006, silk-gloss, matt Float design glass with a clear, vertical stripe, side elements with matt Float ornamental glass (full-surface)

Style 314 recessed grip in Traffic white RAL 9016, matt, flush-fitting stainless steel handle, matt Float ornamental glass

Style 504 stainless steel handle HOE 500, matt Float design glass with 5 clear stripes

→ You will find all colours and surface finishes on page 78.





Style 565



Style 568



Style 650



Style 680



Style 686



Style 823



Style 860



Style 862

THERMOCARBON

All door styles on this page in Slate grey RAL 7015, fine structure matt

Style 565 design handle G 760 in anodised aluminium E6 / EV 1, handle embellishment in anodised aluminium E6 / EV 1

Style 568 design handle G 750 anodised E6 / EV1

Style 650 stainless steel handle HOE 700, Pave white ornamental glass

Style 680 stainless steel handle HOE 700, Pave white ornamental glass

Style 686 stainless steel handle HOE 610, matt Float design glass with 7 clear stripes

Style 823 handle profile in White aluminium RAL 9006, fixing profiles in door colour

Style 860 stainless steel handle HOE 700

Style 862 stainless steel handle HOE 620

→ You will find all colours and surface finishes on page 78.

LEFT. Aluminium entrance door ThermoCarbon style 680, Slate grey RAL 7015, fine structure matt



TopComfort



RC 2 security
Optional



RC 3 security
Optional



High acoustic insulation
Up to 39 dB



Good thermal insulation
 U_D -value of up to 1.3 W/(m²·K)

ENTRANCES FILLED WITH LIGHT. Our TopComfort glass entrance doors create a bright and cheerful entrance area with solid equipment – ideal for blocks of flats or commercial garages. You can choose between 9 exclusive glass door styles that differ in terms of glass design, transparency and how much light they let in.

DOOR OPERATOR HDO. Open and close your TopComfort entrance door easily and automatically. The inconspicuous Flatscan sensor monitors the area of travel and ensures safe operation. The operator can be conveniently operated via buttons, radar / movement detectors and with hand transmitters or radio switches with BiSecur radio technology.

Door operator HDO 200 in combination with a door version without threshold incl. retractable bottom seal, is the ideal solution for barrier-free entrances.



LEFT. Aluminium entrance door TopComfort, Anthracite grey RAL 7016



Style 100



Style 100 design glass or
ornamental glass on request



Style 101



Style 100 MG 111

TOPCOMFORT

All door styles on this page in Traffic white, RAL 9016, matt

Style 100 stainless steel handle 38-1, Master-Carré ornamental glass

Style 100 design glass, on request stainless steel handle HOE 710, matt Float design glass with 7 stripes

Style 101 stainless steel handle 38-1, Master-Carré ornamental glass

Style 100 MG 111 stainless steel handle 38-2, design glass with matt stripes

→ You will find all colours and surface finishes on page 78.



Style 100 MG 112



Style 100 MG 113



Style 100 MG 114



Style 100 MG 115



Style 100 MG 116



Style 100 MG 117

TOPCOMFORT

All door styles on this page in Traffic white, RAL 9016, matt

Style 100 MG 112 stainless steel handle 38-2, Micrograin design glass with horizontal structure

Style 100 MG 113 stainless steel handle 38-2, design glass with 25 matt stripes

Style 100 MG 114 stainless steel handle 38-2, matt design glass with clear semi-circles and stripes

Style 100 MG 115 stainless steel handle 38-2, matt design glass with rectangles

Style 100 MG 116 stainless steel handle 38-2, design glass with matt stripes and crescent

Style 100 MG 117 stainless steel handle 38-2, matt design glass with 9 clear stripes

→ You will find all colours and surface finishes on page 78.

Individualisation

INDIVIDUAL DESIGN. You can custom-equip each of the entrance door styles. You want a special external handle or glazing? We offer a wide range of options to give your entrance door a personal touch. You can even match the door colour to the windows in your home. Pick from numerous smooth or textured preferred colours, or customise your door in a RAL colour of your choice.

→ For further information, see from page 78.





TOP. ThermoSafe style 860 in Hörmann colour CH 703 Anthracite, stainless steel handle HOE 740 adjusted to the door height, side element with clear Float glazing

BOTTOM LEFT. ThermoCarbon style 308 in Ruby red RAL 3003, frame in Anthracite grey RAL 7016, side element with matt Float ornamental glass

BOTTOM CENTRE. ThermoSafe style 504 in Traffic white RAL 9016, side element, Micrograin ornamental glass (Madras basic)

BOTTOM RIGHT. Aluminium entrance door ThermoSafe style with internal design Groove 15 matching residential internal door DesignLine Groove 15, lacquer Traffic white RAL 9016

GENEROUS ENTRANCES. Create stylish, attractive entrances and fill your home with more light. Each entrance door style shown can be combined with side elements and transom lights. The glazings are also totally up to you: either matching the entrance door style or tailored to your taste.

→ For further information, see from page 79.



TOP. TopComfort style 101 with optional side elements and integrated letter box system

LEFT. ThermoSafe style 568 in Hörmann colour CH 703 Anthracite with optional side elements and transom light



PRACTICAL LETTER BOX SYSTEMS. Integrate our elegant letter box systems with high-quality stainless steel panel and insulated aluminium panel infill plate into the side element of your entrance door. Add light switches, intercom mesh and bell buttons for up to 12 households to fit your own individual taste.

→ Available for ThermoSafe and TopComfort



OPERATING COMFORT FOR YOUNG AND OLD. Open your entrance door easily and conveniently with our smart solutions. By code, fingerprint or smartphone. With our lock packages, you are sure to find an intelligent solution that meets your needs. With the Hörmann homee Smart Home control centre, you can conveniently control your Hörmann garage and entrance door, as well as climatic sensors or a camera all with an app. At any time of day or night, from anywhere around the world.

→ For further information, see from page 72.



OPENING AID ECTURN. Once the door is unlocked, lightly press on the door leaf and your entrance door will open and close automatically. Thanks to low-energy operation, there's no risk of crushing or impact. No additional safety equipment is required. The opening aid is integrated elegantly into the door leaf and frame or available as a surface-mounted version.

→ Available for aluminium entrance doors ThermoSafe, ThermoSafe Hybrid, ThermoPlan Hybrid and ThermoCarbon



TOP LEFT. Finger-scan elegantly integrated in the door leaf

TOP CENTRE AND RIGHT. Convenient door opening with opening aid ECTurn

BOTTOM. Hörmann Smart Home control centre homee for all areas of your home

Tip For easy door leaf locking, to carry objects through the door for example, we recommend an overhead door closer with mechanical hold-open device. For further information, please see page 68.



64



74



79



Design. Equipment. Accessories.

- 64 Door leaf construction
- 66 Door versions
- 68 Door equipment
- 70 Security equipment
- 72 Comfort locks
- 74 Exterior handles
- 77 Lever handle sets
- 78 Colours
- 79 Glazings
- 80 Dimensions and fitting data

Door leaf construction

Completely foamed

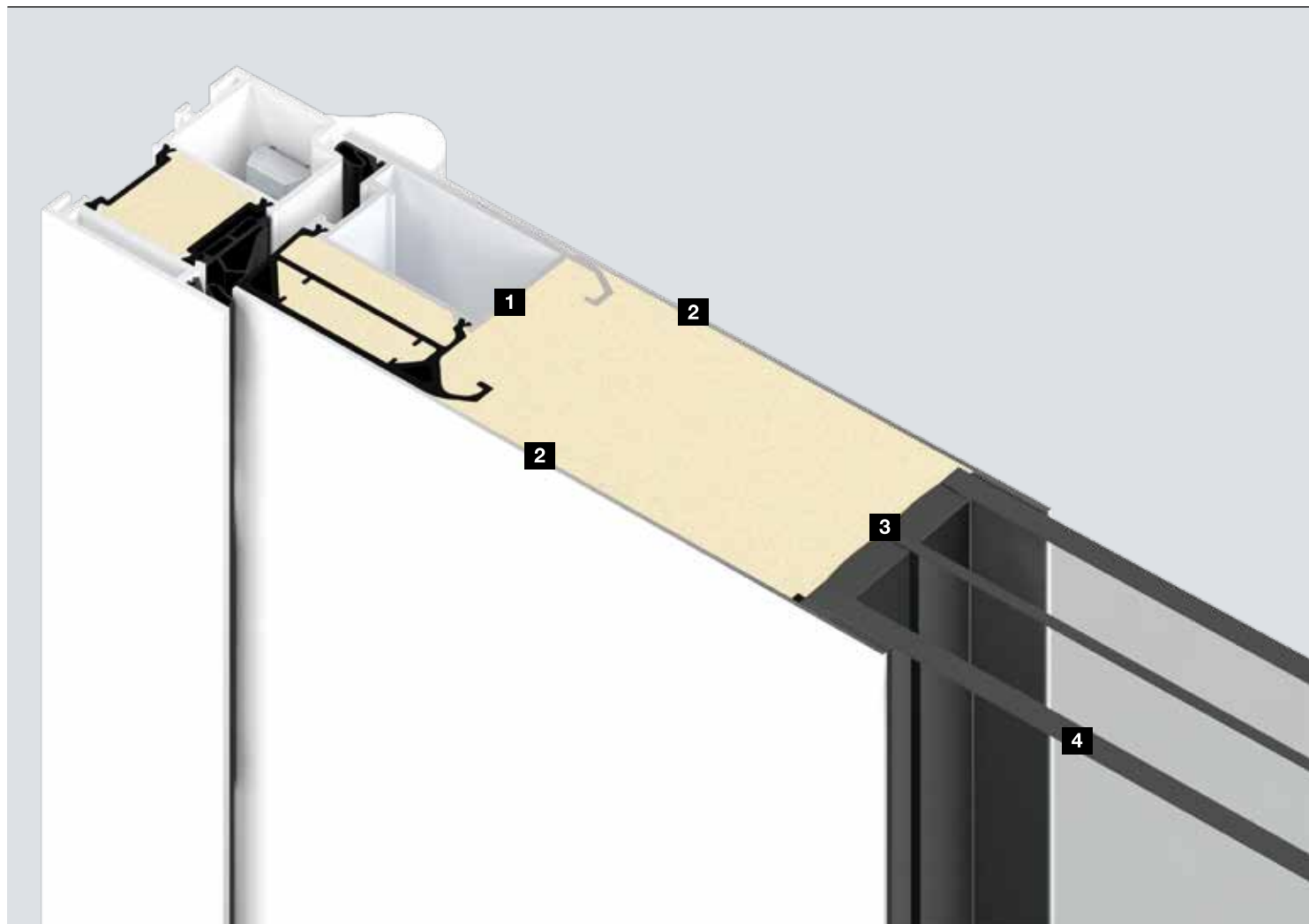

Performance characteristics	ThermoSafe	ThermoSafe Hybrid
Operating forces EN 12217	Up to class 5	Up to class 5
Long-term functionality / mechanical load EN 12400	Up to class 5	Up to class 5
Differential climate behaviour EN 12219	Up to 2d / 2e	Up to 2d / 2e
Air permeability EN 12207	Up to class 4	Up to class 4
Water tightness under heavy rain EN 12208	Up to class 7A	Up to class 7A
Resistance to wind load EN 12210	Up to class C2 / B2	Up to class C2 / B2
Impact resistance EN 13049	Up to class 1	Up to class 1
Mechanical strength EN 1192	Up to class 3	Up to class 3

Note: The specified performance characteristics indicate the maximum possible performance of the entrance door. This performance may vary according to the equipment of the entrance door.

Only from Hörmann

No thermal bridges for glazings and door profile

Only from Hörmann

10 mm P5A laminated safety glass and 8 mm laminated safety glass as standard

Completely foamed door leaf.

With ThermoSafe, ThermoSafe Hybrid, ThermoPlan Hybrid and ThermoCarbon entrance doors, the PU foam is optimally bonded to the door profile **1**, the internal and external sheets **2** and the glazing **3**. In contrast to other door systems, where the components are only glued together, this elegant construction is characterised by a particularly high dimensional stability and break-in resistance as well as even better thermal insulation, as no thermal bridges are created with glazings.

Safe glazing. **4**

When it comes to industrial safety and burglar protection, Hörmann entrance doors fulfil the absolute highest demands. The laminated safety glass on the interior and exterior of the triple-pane insulated glazing provides maximum security. In case of glass breakage, the glass splinters are also bound on the inside, virtually eliminating any danger of being injured by the shards. Furthermore, the laminated safety glass offers better protection against burglars as it makes reaching through more difficult.

ThermoPlan Hybrid

ThermoCarbon

TopComfort

Up to class 5

Up to class 3

Up to class 3

Up to class 5

Up to class 6

Up to class 5

Up to 2d / 1e

Up to 2d / 2e

Up to 2d / 2e

Up to class 4

Up to class 4

Up to class 4

Up to class 7A

Up to class 7A

Up to class 5A

Up to class C2 / B2

Up to class C2 / B2

Up to class C2

Up to class 1

Up to class 5

Up to class 1

Up to class 3

Up to class 3

Up to class 3

Door versions

The right profile for any requirement

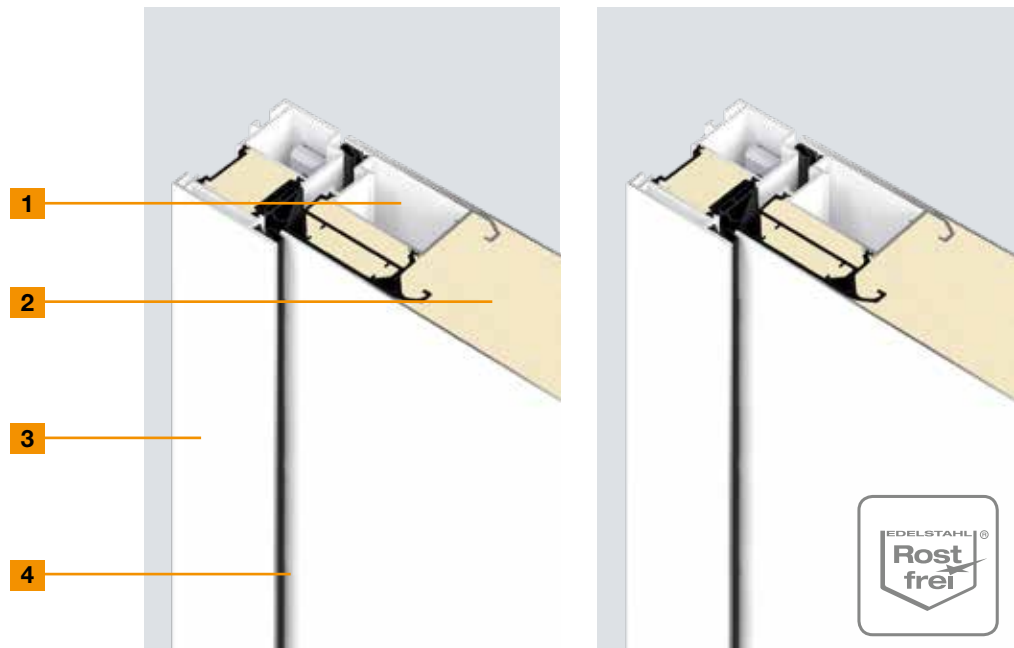

ThermoSafe

ThermoSafe Hybrid

1	Door profile	Interior	Interior
	Material	Aluminium, with thermal break	Aluminium, with thermal break
2	Door leaf thickness	73 mm	73 mm
	External sheet	Aluminium	Stainless steel
	External rebate	Rebated	Rebated
	Internal sheet	Aluminium	Aluminium
	Internal rebate	Flush	Flush
3	Frame thickness	82 mm	82 mm
	Material	Aluminium, with thermal break	Aluminium, with thermal break
4	Sealing system	3 ×	3 ×
	Threshold	Aluminium / plastic	Aluminium / plastic
	Thermal insulation (U_D value)*	Up to 0.87 W/(m²·K)	Up to 0.87 W/(m²·K)
	Acoustic insulation	Up to 34 dB	Up to 36 dB



ThermoPlan Hybrid



ThermoCarbon

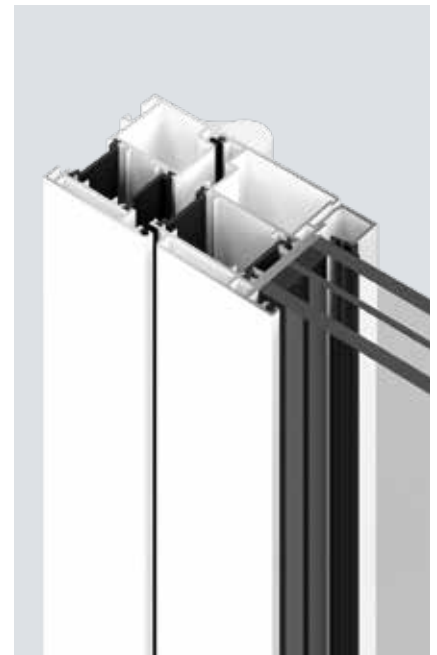

TopComfort

Interior	Interior	Glazing frame
Aluminium, with thermal break	Carbon, with thermal break	Aluminium, with thermal break
82 mm	100 mm	80 mm
Stainless steel	Aluminium	
Flush	Rebated	Flush
Aluminium	Aluminium	
Flush	Rebated	Flush
82 mm	111 mm	80 mm
Aluminium, with thermal break	Aluminium, with thermal break	Aluminium, with thermal break
3 ×	4 ×	2 ×
Aluminium / plastic	Aluminium / plastic	Aluminium / plastic
Up to 0.78 W/(m²·K)	Up to 0.47 W/(m²·K)	Up to 1.3 W/(m²·K)
Up to 36 dB	Up to 35 dB	Up to 39 dB

Only from Hörmann
 U_b -value of up to 0.47 W/(m²·K)

* Dependent on door size. Specified values for RAM 1250 × 2200 mm

Door equipment

For an elegant, functional door design

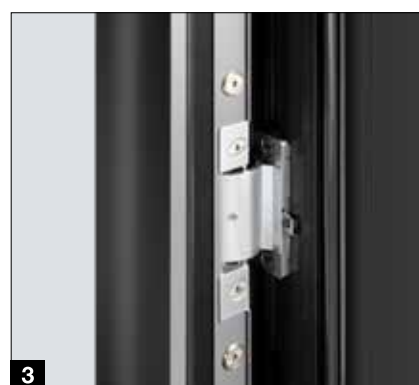

ThermoSafe

ThermoSafe Hybrid

	ThermoSafe	ThermoSafe Hybrid
1 Solid door view from the inside	●	●
2 3-way adjustable hinges, Traffic white RAL 9016	●	●
3 Concealed hinges	○	○
4 Electro duct with spiral cable	○	○
5 Electro duct with cable strap	○	○
6 Interior lever	Aluminium, Traffic white RAL 9016	Aluminium, Traffic white RAL 9016
7 Stainless steel lock plate	●	●
8 Thermal insulation glazing	Triple-pane glazing	Triple-pane glazing
9 Integrated overhead door closer or overhead door closer HDC 35 (not shown) with mechanical hold-open device	○	○
Opening limiter	○	○
10 Retractable bottom seal with weather protection	○	○

● = As standard ○ = Optional - = Not available



ThermoPlan Hybrid

ThermoCarbon

TopComfort

<input checked="" type="checkbox"/>	<input checked="" type="checkbox"/>	<input checked="" type="checkbox"/>
<input checked="" type="checkbox"/>	-	<input checked="" type="checkbox"/>
<input type="checkbox"/>	<input checked="" type="checkbox"/>	<input type="checkbox"/>
<input type="checkbox"/>	-	<input type="checkbox"/>
<input type="checkbox"/>	<input type="checkbox"/>	-
Aluminium, Traffic white RAL 9016	Stainless steel	Aluminium, Traffic white RAL 9016
<input checked="" type="checkbox"/>	<input checked="" type="checkbox"/> (Integrated in rebate)	<input checked="" type="checkbox"/>
Triple-pane glazing	Quadruple-pane glazing	Triple-pane glazing
<input type="checkbox"/>	<input type="checkbox"/>	-
<input type="checkbox"/>	-	<input type="checkbox"/> With scissors limiter
-	-	<input type="checkbox"/> Without weather protection

Security equipment

Certified security equipment as standard



ThermoSafe

ThermoSafe Hybrid

1	Profile cylinder with flush-fitting security rose escutcheon	-	-
2	Profile cylinder with surface-mounted security rose escutcheon	●	●
3	Security lock with swing bolt and mechanical locking	● H5 with 5-point locking	● H5 with 5-point locking
	Electric strike with day / night function	○	○
	Electric strike with day / night function and permanently open function	○	○
4	Security lock with bolt and mechanical self-locking	■ S5 Automatic with 5-point locking	■ S5 Automatic with 5-point locking
4	Security lock with bolt, arrestor hook and mechanical self-locking	○ S5S Automatic with 5-point locking	○ S5S Automatic with 5-point locking
	Leverage protection* on the hinge side	●	●
	RC 2 security equipment	●	●
	RC 3 security equipment	●	●
	RC 4 security equipment	-	● For door styles without glazing and with H5 lock

● = As standard ■ = Optional at no surcharge ○ = Optional - = Not available

* Not required with concealed hinges



RC 2 security
Tested and certified

The opportunist burglar attempts to break open the locked door with simple tools within 3 minutes.



RC 3 security
Tested and certified

The burglar attempts to break open the locked door with simple tools, e.g. a crowbar, as well as simple drilling tools within 5 minutes.



RC 4 security
Tested and certified

The experienced burglar attempts to break open the locked door with simple tools, e.g. a crowbar, as well as simple striking tools within 10 minutes.



ThermoPlan Hybrid

ThermoCarbon

TopComfort

<input checked="" type="checkbox"/>	<input checked="" type="checkbox"/>	<input checked="" type="checkbox"/>
-	-	-
<input checked="" type="checkbox"/> H5 with 5-point locking	<input checked="" type="checkbox"/> H9 with 9-point locking	<input checked="" type="checkbox"/> H5 with 5-point locking
<input type="checkbox"/>	<input type="checkbox"/>	<input type="checkbox"/>
<input type="checkbox"/>	<input type="checkbox"/>	<input type="checkbox"/>
<input checked="" type="checkbox"/> S5 Automatic with 5-point locking	<input checked="" type="checkbox"/> S7 Automatic with 7-point locking	<input checked="" type="checkbox"/> S5 Automatic with 5-point locking
<input type="checkbox"/> S5S Automatic with 5-point locking	-	<input type="checkbox"/> S5S Automatic with 5-point locking
<input checked="" type="checkbox"/>	Not required	<input checked="" type="checkbox"/>
<input checked="" type="checkbox"/>	<input checked="" type="checkbox"/>	<input type="checkbox"/>
<input checked="" type="checkbox"/>	<input checked="" type="checkbox"/>	<input type="checkbox"/>
-	<input type="checkbox"/>	-

Comfort locks

Smart security

Automatic security lock S5 / S7 with electric motor

The lock is equipped with an electric motor with automatic self-locking that unlocks the bolt of your entrance door with an electric impulse. Depending on the lock version, you can either open your entrance door from inside via a button on an existing house intercom or from outside via code, fingerprint, radio or Bluetooth.

	S5 / S7 Comfort	S5 / S7 Code	S5 Touch- Code & Bluetooth	S5 / S7 Scan	S5 / S7 Smart	S5 / S7 BlueSecur
Connection to house intercom	●	●	●	●	●	●
Code switch in the door leaf		●				
Code switch in the door handle		○				
Touch code switch in the door leaf			●			
Finger-scan in the door leaf				●		
Finger-scan in the door handle				○		
BiSecur radio		○	○	○	●	
Bluetooth receiver for Hörmann BlueSecur		○		○		●

● = As standard ○ = Optional

S5 = 5-point locking for ThermoSafe, ThermoSafe Hybrid, ThermoPlan Hybrid

S7 = 7-point locking for ThermoCarbon

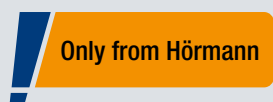

All automatic locks with electric motor can optionally be equipped with the BiSecur radio system, allowing you to conveniently open your entrance door with an optional hand transmitter, radio switch or the Hörmann homee Smart Home control centre.

Another advantage is that you can use the same hand transmitter to operate your Hörmann garage door or entrance gate. The extremely secure radio system ensures that no unauthorised person can copy your radio signal. All operators, receivers and controls with the BiSecur radio system are 100% compatible with each other.



Further information can be found in the "Garage door and entrance gate operators" brochure.



Code switches

Fitting in door handle HOE 605 (see figure left) or on the door leaf, for up to 20 codes, dimensions: 45 x 75 mm

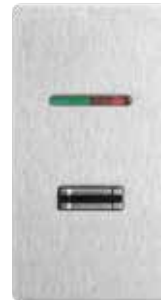

Finger-scan

Fitting in door handle HOE 506 / HOE 606 or on the door leaf, for up to 150 fingerprints, VDS-approved, dimensions: 45 x 75 mm



Touch code switch, black

Fitting in the door leaf, with touch-sensitive touch surface, for up to 20 codes, dimensions: 56 x 102 mm

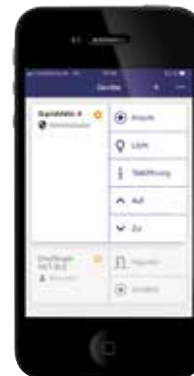

Bluetooth receiver

For operation by smartphone using the Hörmann BlueSecur app

 **Hörmann BlueSecur**

Only from Hörmann

European patent

Conveniently open and close your door via Bluetooth using your smartphone. Lock and unlock your entrance door using the user-friendly Hörmann BlueSecur app. In addition, other user permissions can be permanently or temporarily transferred to other smartphones, so that every family member always has their “entrance door opener” with them.

Exterior handles

Tangibly beautiful design



HOE 500
Brushed matt stainless steel
Handle length¹: 1000 mm

HOE 501
Brushed stainless steel
Handle length¹: 1000 mm

HOE 501 black.edition
■ **NEW**
Jet black RAL 9005
Handle length¹: 1000 mm

HOE 506
Brushed stainless steel, prepared for a finger-scan
Handle length¹: 1000 mm

HOE 600/610/615
Brushed stainless steel
Handle lengths¹: 950 mm (HOE 600), 1100 mm (HOE 615), 1250 mm (HOE 610)

HOE 605
Brushed stainless steel, prepared for a code switch
Handle length¹: 1000 mm



38-1
Polished stainless steel with decorative centre part
Handle length¹: 1000 mm

38-2
Brushed stainless steel
Handle length¹: 1000 mm

HOE 800
Polished stainless steel with decorative centre part
Handle length³: 330 mm

14-1
Polished stainless steel with decorative centre part
Handle length³: 330 mm

14-2
Brushed stainless steel
Handle length³: 330 mm

14-4 ■ **NEW**
Polished brass
Handle length³: 330 mm



HOE 700

Polished stainless steel with decorative centre part
Handle length¹: 1000 mm

HOE 701

Stainless steel with decorative centre part
Handle length¹: 1000 mm

HOE 706

Brushed stainless steel, prepared for a finger-scan
Handle length¹: 1000 mm

HOE 710

Brushed stainless steel
Handle length: adjusted to door height

HOE 730

Brushed stainless steel
Handle length⁶: 1876 mm

HOE 740

Brushed stainless steel
Handle length²: adjusted to door height

HOE 795 / 796

Brushed stainless steel
Handle lengths²: 1000 mm (HOE 795), 600 mm (HOE 796)

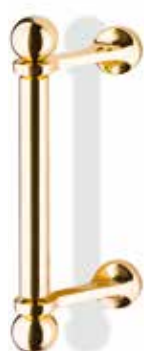

81-1

Polished brass
Handle length¹: 290 mm



92-2

Brushed stainless steel
Handle length⁴: 350 mm

94-2

Brushed stainless steel
Handle length⁵: 300 mm

Spacing of fixings:

- ¹ 600 mm
- ² 980 mm / 580 mm
- ³ 210 mm
- ⁴ 350 mm
- ⁵ 300 mm
- ⁶ 1770 mm

Exterior handles

Design handles, adjusted to the door height

Design handle G 750



Handle bar in E6 / EV1, end cap in stainless steel

Handle bar in Traffic white RAL 9016, end cap in stainless steel

Handle bar black.edition in Jet black RAL 9005 (RAL to choose), end cap in Jet black RAL 9005

Design handle G 760



Handle bar in anodised aluminium E6 / EV 1, handle embellishment in CH 703 Anthracite, end cap in stainless steel

Handle bar in CH 703 Anthracite, handle embellishment in CH 703 Anthracite, end cap in stainless steel

Handle bar black.edition in Jet black RAL 9005, handle embellishment in Jet black RAL 9005 (RAL to choose), end cap in Jet black RAL 9005



Handle bar in anodised aluminium E6 / EV 1, handle embellishment in anodised aluminium E6 / EV 1, end cap in stainless steel

Handle bar in anodised aluminium E6 / EV 1, handle embellishment in Traffic white RAL 9016, end cap in stainless steel

Handle bar in anodised aluminium E6 / EV 1, handle embellishment in Jet black RAL 9005 (RAL to choose), end cap in stainless steel

Handle bar in anodised aluminium E6 / EV 1, handle embellishment in Decograin Golden Oak, end cap in stainless steel

Handle embellishments are also available in timber designs

Maximum handle length 2100 mm



1 Decograin Light Oak

2 Decograin Golden Oak

3 Decograin Dark Oak

4 Decograin Night Oak

5 Decograin Rosewood

Lever handle sets

Excellent design and security



Aluminium lever handle Rondo

In matt Traffic white, RAL 9016 as standard for ThermoSafe, ThermoSafe Hybrid, ThermoPlan Hybrid and TopComfort



Stainless steel lever handle Caro

As standard for ThermoCarbon and optionally for ThermoSafe, ThermoSafe Hybrid, ThermoPlan Hybrid and TopComfort



Stainless steel lever handle Okto

Optionally for ThermoSafe, ThermoSafe Hybrid, ThermoPlan Hybrid and TopComfort



Stainless steel lever handle set D-116

Optionally for ThermoSafe, ThermoSafe Hybrid, ThermoPlan Hybrid and TopComfort



Stainless steel lever handle set D-335

Optionally for ThermoSafe, ThermoSafe Hybrid, ThermoPlan Hybrid and TopComfort



Aluminium lever handle D-360 ■ NEW

black.edition in matt Jet black, RAL 9005, optionally for ThermoSafe, ThermoSafe Hybrid, ThermoPlan Hybrid and ThermoCarbon



Aluminium lever handle D-360 ■ NEW

In matt Traffic white, RAL 9016, optionally for ThermoSafe, ThermoSafe Hybrid, ThermoPlan Hybrid and ThermoCarbon



Stainless steel lever handle D-360 ■ NEW

Optionally for ThermoSafe, ThermoSafe Hybrid, ThermoPlan Hybrid and ThermoCarbon



Stainless steel lever handle D-360 ■ NEW

Optionally for ThermoSafe, ThermoSafe Hybrid, ThermoPlan Hybrid and ThermoCarbon



Aluminium security handle set 62-1

Optionally for ThermoSafe, ThermoSafe Hybrid, ThermoPlan Hybrid and TopComfort (not for RC 3 security equipment)



Stainless steel security handle set 62-4

In matt Traffic white, RAL 9016, optionally for ThermoSafe, ThermoSafe Hybrid, ThermoPlan Hybrid and TopComfort (not for RC 3 security equipment)

Colours

Standard and preferred colours

Standard and preferred colours, matt



Standard colour

1 RAL 9016 Traffic white

Preferred colours, matt

2 RAL 9016 Traffic white (high-gloss)

3 RAL 9006 White aluminium (silk-gloss)

4 RAL 8028 Terra brown

5 RAL 7040 Window grey

6 RAL 7035 Light grey

7 RAL 7030 Stone grey

8 RAL 7016 Anthracite grey

9 RAL 7015 Slate grey

10 RAL 6009 Fir green

11 RAL 6005 Moss green

12 RAL 3003 Ruby red

Preferred colours, fine structure matt



Preferred colours, fine structure matt

1 RAL 9007 Grey aluminium

2 RAL 9001 Cream

3 RAL 7039 Quartz grey

4 RAL 7030 Stone grey

5 RAL 7016 Anthracite grey

6 RAL 7015 Slate grey

7 Hörmann colour CH 703 Anthracite

8 Hörmann colour CH 607 Chestnut

Glazings

Custom glazings and design glass



- 1** Float, clear / clear glass
- 2** Float, matt / sand-blasted
- 3** Satinato
- 4** Pave white
- 5** Parsol grey
- 6** Parsol grey, matt
- 7** Ornament 504
- 8** Ornament 553
- 9** Chinchilla
- 10** Micrograin (Madras basic)
- 11** Reflo, clear
- 12** Reflo, matt
- 13** Silk
- 14** Master-Carré
- 15** Baroque white
- 16** Niagara white
- 17** Gothic white
- 18** Cathedral white
- 19** Cast antique white
- 20** Uadi white

Dimensions and fitting data

ThermoSafe / ThermoSafe Hybrid

ThermoSafe / ThermoSafe Hybrid entrance door sizes

70 mm frame version	Overall frame dimension ¹ (ordering size)	Structural opening ¹	Clear frame dimension
Standard	Max. 1250 × 2250	Max. 1270 × 2260	Max. 1110 × 2180
Oversize	Max. 1250 × 2350	Max. 1270 × 2360	Max. 1110 × 2280
XXL	Max. 1250 × 2500	Max. 1270 × 2510	Max. 1110 × 2430

ThermoSafe / ThermoSafe Hybrid side element sizes

Vertical profile construction	Side element height ¹	TM side element width ¹	TM entrance door width ¹
1-sided	Max. 3000	260 – 1600	Max. 1230
2-sided	Max. 3000	260 – 1600	Max. 1210

The max. transport size of a door assembly (incl. side elements, transom lights and surface-mounted profiles) must not exceed 2700 mm on any side.

Coupling construction	Side element height ¹	TM side element width ¹	TM entrance door width ¹
1-/2-sided	Max. 3000	300 – 2500 ²	1250

¹ For 110 mm frames + 40 mm
² With Reflo or Micrograin glazing

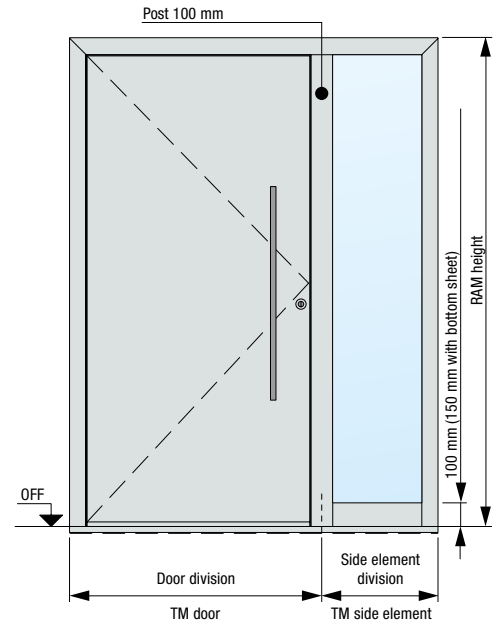

Horizontal view of door

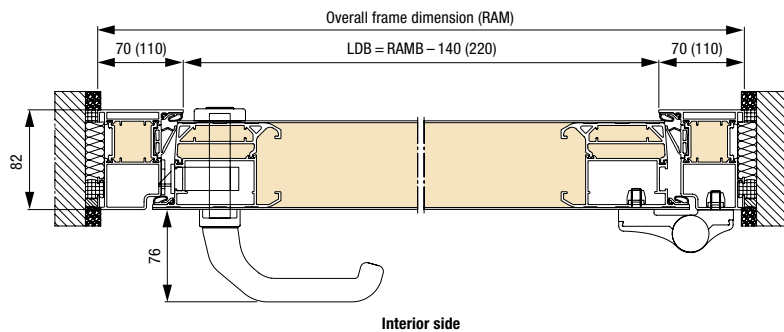

Vertical view of door

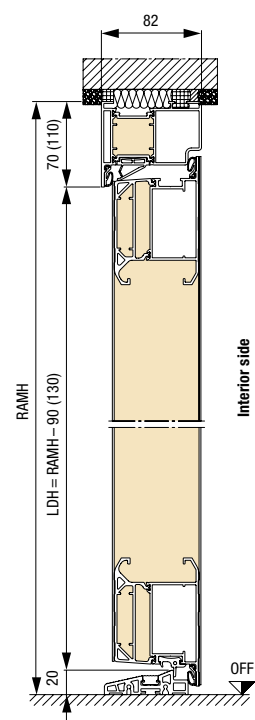

Bottom spacer profile / transport protection

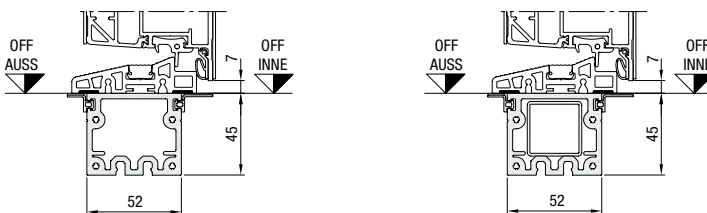

For vertical profile constructions with inserted, continuous tubular supports

Dimensions in mm

ThermoPlan Hybrid entrance door sizes

70 mm frame version	Overall frame dimension ¹ (ordering size)	Structural opening ¹	Clear frame dimension
Standard	Max. 1250 × 2250	Max. 1270 × 2260	Max. 1110 × 2180
Oversize	Max. 1250 × 2350	Max. 1270 × 2360	Max. 1110 × 2280
XXL	Max. 1250 × 2500	Max. 1270 × 2510	Max. 1110 × 2430

ThermoPlan Hybrid side element sizes

Vertical profile construction	Side element height ¹	TM side element width ¹	TM entrance door width ¹
1-sided	Max. 3000	260 – 1600	Max. 1230
2-sided	Max. 3000	260 – 1600	Max. 1210

The max. transport size of a door assembly (incl. side elements, transom lights and surface-mounted profiles) must not exceed 2700 mm on any side.

Coupling construction	Side element height ¹	TM side element width ¹	TM entrance door width ¹
1-/2-sided	Max. 3000	300 – 2500 ²	1250

¹ For 110 mm frames + 40 mm

² With Reflo or Micrograin glazing

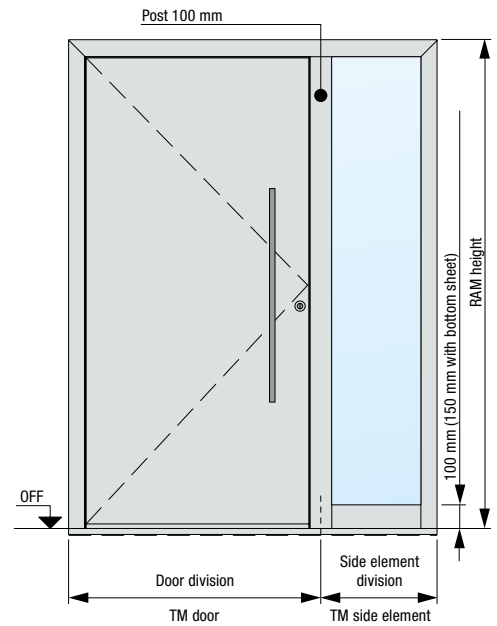

Horizontal view of door

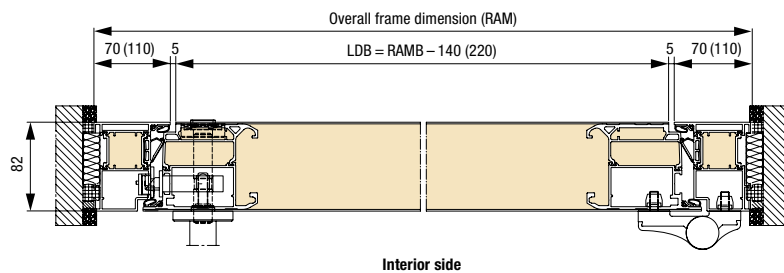

Vertical view of door

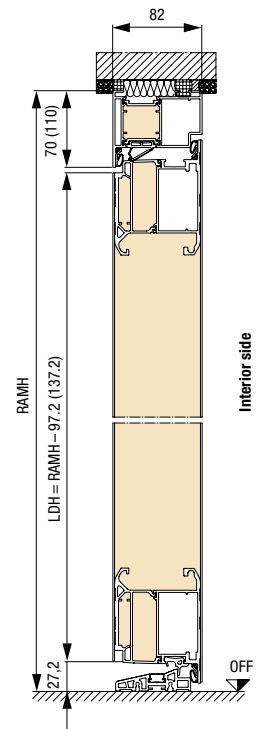

Bottom spacer profile / transport protection

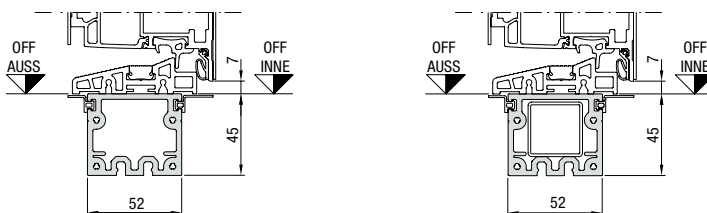

For vertical profile constructions with inserted, continuous tubular supports

Dimensions and fitting data

ThermoCarbon

ThermoCarbon entrance door dimensions

70 mm frame version	Overall frame dimension ¹ (ordering size)	Structural opening ¹	Clear frame dimension
Standard	Max. 1340 × 2350	Max. 1360 × 2360	Max. 1140 × 2230
XXL	Max. 1340 × 3000	Max. 1360 × 3010	Max. 1140 × 2880

ThermoCarbon side element dimensions

Vertical profile construction	Side element height ¹	TM side element width ¹	TM entrance door width ¹
1-sided	Max. 3000	300 – 1600	Max. 1300
2-sided	Max. 3000	300 – 1600	Max. 1260

The max. transport size of a door assembly (incl. side elements, transom lights and surface-mounted profiles) must not exceed 2700 mm on any side.

Coupling construction	Side element height ¹	TM side element width ¹	TM entrance door width ¹
1-/2-sided	Max. 3000	340 – 1600	1340

¹ For 110 mm frames + 40 mm

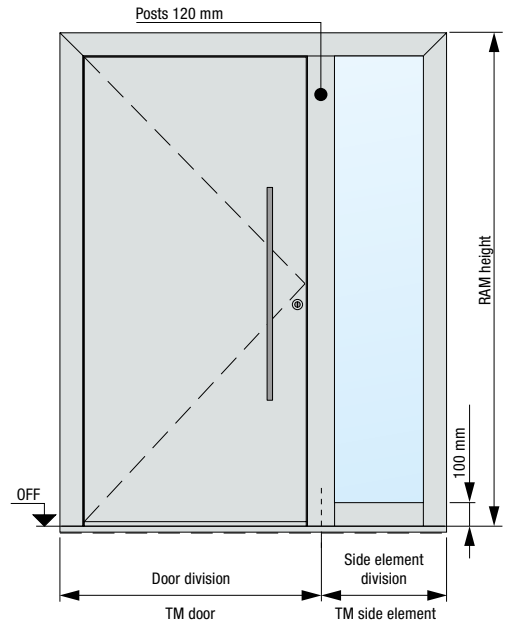

Horizontal view of door

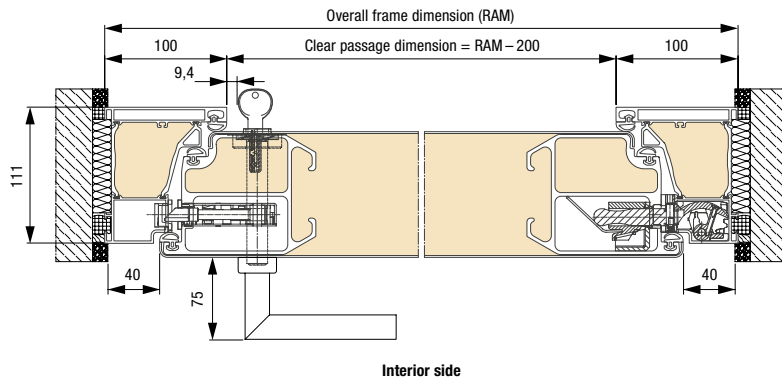

Vertical view of door

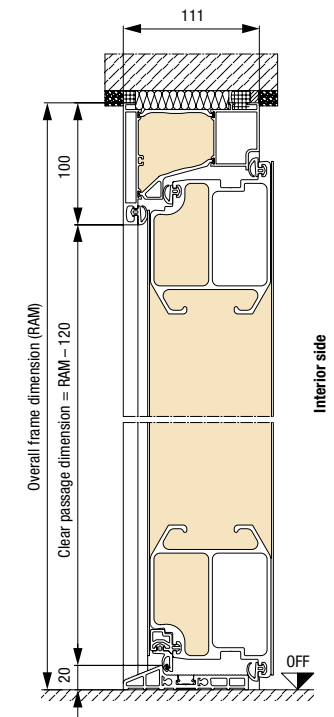

Bottom spacer profile / transport protection

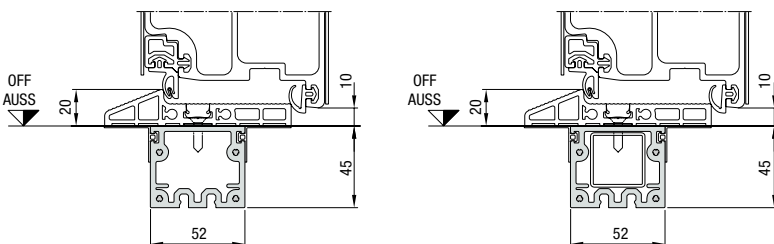

For vertical profile constructions with inserted, continuous tubular supports

TopComfort entrance door sizes

70 mm frame version	Overall frame dimension ¹ (ordering size)	Structural opening ¹	Clear frame dimension
Standard	Max. 1300 × 2500	Max. 1270 × 2510	Max. 1160 × 2430

TopComfort side element sizes

Vertical profile construction	Side element height ¹	TM side element width ¹	TM entrance door width ¹
1-sided	Max. 3000	260 – 1600	Max. 1230
2-sided	Max. 3000	260 – 1600	Max. 1210

The max. transport size of a door assembly (incl. side elements, transom lights and surface-mounted profiles) must not exceed 2700 mm on any side.

Coupling construction	Side element height ¹	TM side element width ¹	TM entrance door width ¹
1-/2-sided	Max. 3000	300 – 1600	1250

¹ For 110 mm frames + 40 mm

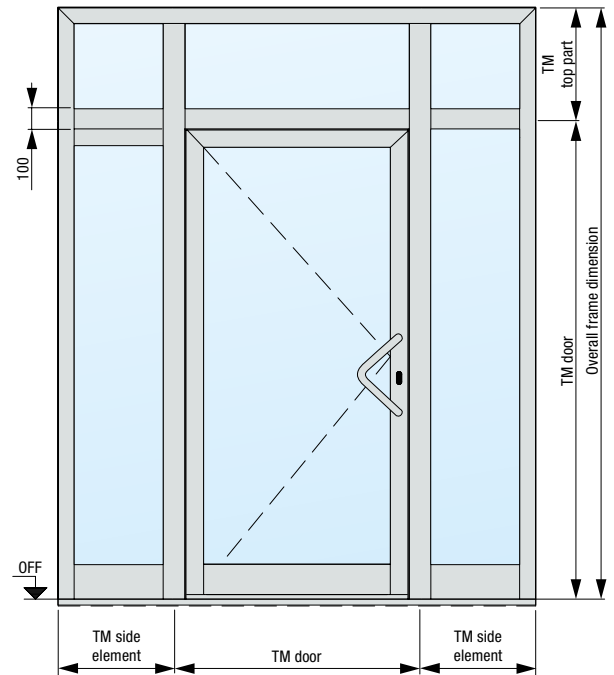

Horizontal view of door

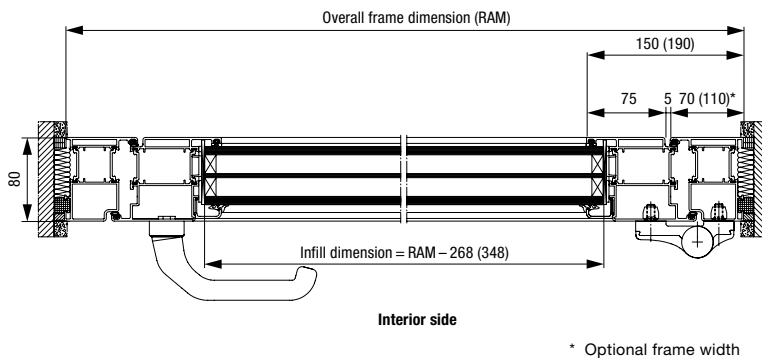

Vertical view of door

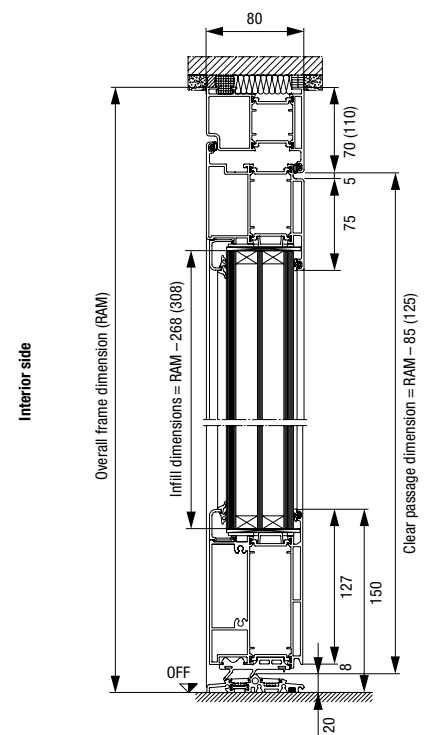

Bottom spacer profile / transport protection

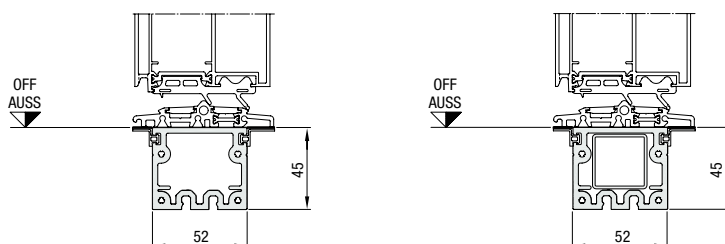

For vertical profile constructions with inserted, continuous tubular supports

Experience Hörmann quality in new construction and modernisation

Hörmann provides an excellent basis for comprehensive planning. Carefully matched solutions offer you the very best in perfectly designed products for every area.

**GARAGE DOORS. GATE AND DOOR OPERATORS. ENTRANCE DOORS.
RESIDENTIAL INTERNAL DOORS. STEEL DOORS. FRAMES.**



Some of the doors shown are equipped with optional extras and do not always correspond to the standard versions. The surface finishes and colours shown are subject to the limitations of the printing process and cannot be regarded as binding. All rights reserved. No part may be reproduced without our prior permission. Subject to changes.