



# RESIDENTIAL INTERNAL DOORS

**NEW.** Matt real lacquer surface finish for a puristic and modern interior

**HÖRMANN**





4

Good reasons to try  
Hörmann residential  
internal doors.



12

Door styles.  
Inspirations.



74

Design.  
Equipment.  
Accessories.

# Responsibility for generations

The Hörmann family business has over 85 years of experience as a construction component specialist. This gives us an obligation to both current and future generations. That's why environmental responsibility plays such an important role for us. With this in mind, we develop innovative solutions for sustainable products and intelligent environmental protection.



## “A GOOD REPUTATION MUST BE EARNED.”

August Hörmann

In keeping with the tradition started by the company's founder, the Hörmann brand is a true promise of quality and one of Europe's most successful suppliers in the area of construction components. Due to the comprehensive international sales and service network, Hörmann is your strong partner for high-quality construction components.



**SUSTAINABLE FORESTRY.** We attach huge importance to timber from sustainably managed forests when buying raw timber materials. Our responsibility: We want there to be enough timber, an environmentally friendly and renewable raw material, for future generations so that forests can fulfil their ecological and social functions.

**100% CLIMATE-NEUTRAL.** Hörmann sets a good example: In Germany, 100% of our energy needs come from green electricity. Together with an intelligent and certified energy management system, CO<sub>2</sub>-neutral mailing and the recycling of valuable materials, more than 60000 tons of CO<sub>2</sub> are saved each year. We also offset unavoidable emissions in the production of our residential internal doors 100% by promoting wind energy and reforestation projects in cooperation with ClimatePartner. All Hörmann residential internal doors feature the “climate-neutral” label.



You can find further information at  
[www.hormann.co.uk/company/environment](http://www.hormann.co.uk/company/environment)



# Brand quality made in Germany



The family-owned company Hörmann offers all important construction components for building and renovating projects from a single source. We manufacture in highly specialised factories using state-of-the-art production technologies. Our employees work intensively on new products, continual further developments and improvements to details. The results are patents and unique products on the market.



**LONG-LASTING. GUARANTEED.** All doors are developed and manufactured by Hörmann. Endurance tests under real conditions ensure mature series products with Hörmann quality. For this reason and thanks to quality assurance without compromise, you can enjoy a Hörmann residential internal door for years to come because you are literally choosing a “door for life”.

**CONVINCING PREMIUM WORKMANSHIP.** For the door and frame construction, we rely exclusively on high-quality timber materials. Screw connections guarantee an excellent fit and seamless frame appearance. Frame reinforcements in the door leaf and sturdy door fittings ensure high stability and resistance. The modern, in-house production technology for the Duradecor surface finish impresses with consistently high quality and an impact resistance that is on average 48% better than that of tested CPL surfaces of other manufacturers.



**EPH**  
EXCELLENCE BY QUALITY  
 Technologie- und Holzwerkstoffherstellung GmbH  
 Löhninger Weg 10 · 40111 Essen · Germany  
 www.eph.de · Tel. +49 (0)201 40000-100  
 Fax +49 (0)201 40000-100



IMALS  
 Institut für Materialprüfung  
 und Werkstofftechnik

## KURZBERICHT

**Auftrags-Nr.: 2713082-2013**  
 Seite 1 von 3

<b>Auftraggeber (AG):</b>	Hörmann KG Verkaufsgesellschaft Löhninger Weg 34 - 38 33801 Steinhagen
<b>Auftrag vom:</b>	11.03.2013
<b>Prüfgegenstand:</b>	5 Türlattener mit CPL-Beschichtung (Variante 1 + 6) verschiedener Hersteller 3 Türlattener mit Duradecor-Beschichtung (Variante 7 - 9) von Hörmann
<b>Prüfmaßnahme:</b>	Anlieferung durch AG am 14.03.2013
<b>Prüfauftrag:</b>	Durchführung ausgewählter Prüfungen an Türlattenoberflächen
<b>Prüfgrundlagen:</b>	<ol style="list-style-type: none"> <li>1. Bestimmung der Fleckenunempfindlichkeit nach EN 12720/ DIN EN/TS 16209</li> <li>2. Bestimmung des Verhaltens bei Stoßbeanspruchung mit einer kleinen Kugel gemäß den Prüfbedingungen der EN 438-2:2005, Abschnitt 20</li> <li>3. Bestimmung der Kratzfestigkeit gemäß EN 15186 Verfahren B</li> <li>4. Bestimmung der Tausalteigkeit gemäß IHD-W-463 und Beurteilung der Prüfflächen gemäß den Bewertungsstufen</li> <li>5. Bestimmung des Verhaltens bei Abriebbeanspruchung nach EN 438-2:2005, Abschnitt 10</li> <li>6. Bestimmung der Lichtstichheit gemäß DIN EN 438-2, Pkt. 27</li> <li>7. Bestimmung des Verhaltens gegenüber Wasserdampf gemäß EN 438-2:2005, Abschnitt 14</li> <li>8. Bestimmung des Verhaltens gegenüber trockener Hitze gemäß EN 12722/ Klassifizierung nach DIN 68863 Teil 7/ DIN EN/TS 16209</li> <li>9. Bestimmung des Verhaltens gegenüber feuchter Hitze gemäß EN 12721/ Klassifizierung nach DIN 68863 Teil 8/ DIN EN/TS 16209</li> <li>10. Bestimmung der Haftfestigkeit der Beschichtung in Anlehnung an DIN EN ISO 4624</li> <li>11. Bestimmung der Wasserdampfdurchlässigkeit mittels Bestimmung der Wasseraufnahme bei einer Lagerung von 14 Tagen bei 20 °C/ 98 % relativer Luftfeuchte, Angabe der Wasseraufnahmemenge in g/m<sup>2</sup></li> <li>12. Bestimmung der Wuchbeständigkeit nach IHD-W-471</li> </ol>

Der Prüfbericht enthält 3 Seiten. Eine ausgereifte Vervielfältigung bedarf der schriftlichen Genehmigung des EPH. Die Prüfergebnisse beziehen sich ausschließlich auf die geprüften Materialen.

# Premium quality that you can feel in form and design

Your interior style sets the tone! You'd like residential internal doors that harmonise with your home? Get ready to be impressed by the high-quality Duradecor surface finish with vibrant colours, perfectly reproduced timber decors and expressive textures. You can also choose from numerous real lacquer surface finishes and real timber veneers. Or you can design your residential internal doors yourself with the paintable priming film. It does not get any more individual than that!







**Duradecor**  
Extremely impact resistant

**PERMANENT DURABILITY.** With an impact resistance that is on average 48% better, the high-quality Duradecor surface finish is clearly superior to CPL surfaces of other manufacturers. It is also especially easy to clean, heat-resistant and almost as robust as a kitchen worktop.



**4Protect edge guard**

**RESISTANT EDGE.** The 4Protect edge guard on flush-closing doors and rebated doors with angular edges offers a high resistance to impact, wear and scratches. This makes doors with a Duradecor surface finish ideally protected against everyday stress.

**SEAMLESS WHITE.** The rebate edge of all doors with a white Duradecor surface finish is specially coated for a seamless appearance. In addition, the 4Protect edge guard ensures a seamless transition to the door leaf in doors with angular edges. You can enjoy a continuously white door view without bothersome unsightly edges, as with standard doors.

→ Further information about the 4Protect edge guard can be found on page 91.

4Protect edge guard with seamless appearance on flush-closing doors and rebated doors with angular edges



# The long-lasting frame

Our high-quality timber and steel frames give your home twice the pep: The frames feature an elegant, attractive appearance, thereby giving your home an attractive cosiness. At the same time, the frames are extremely durable. Their high-quality, robust design makes them highly resistant, and they remain easy to clean in the long run.





**HIGH-QUALITY TIMBER FRAME.** The elegant 3 mm **1** edge radius impresses with a modern rectangular look and a seamless edge finish. The 25-mm-thick jamb lining **2** ensures high form stability, and the premium-quality Duradecor surface finish **3** also makes the frame particularly resistant to impacts and scratches.

→ Further information can be found starting on page 76.



**ROBUST STEEL FRAME VARIOFIX.** In addition to the standard timber frames, all our residential internal doors are also available with the powder-coated VarioFix steel frame. The corner joints feature high-quality welding and a flush polish, so that there are no visible mitre cuts in the frame corners. The robust frame construction can also withstand run-ins with toy cars or vacuum cleaners and guarantees a uniform gap dimension with flush-closing doors, as it no longer warps after fitting. Thanks to the high-quality galvanization, even cleaning water cannot damage the frame.

→ Further information can be found on page 93.





# Discover the new feeling of home

You're looking for premium residential internal doors in a classic or modern style, with large glazings, elegant accents or a cool loft design? Hörmann offers you the residential internal door that perfectly suits you and your furnishings.



16 BaseLine



28 DesignLine Concepto



32 DesignLine



46 ClassicLine



54 GlassLine



60 Steel loft doors



64 Sliding doors



70 Function doors and accessories











# BaseLine

**TIMELESSLY ELEGANT.** Do you value the feel-good character in your home? Then the doors from the BaseLine series are the right choice for you. The door leaf in a flush or rebated version, combined with your preferred colour or your preferred decor, creates a cosy atmosphere that invites you to relax. Discover all design possibilities on the next pages.

## Door versions

-  Rebated with rounded edges
-  Rebated with angular edges
-  Flush

→ Further information about the door versions can be found on page 90.



Rebated, single-leaf



Rebated, double-leaf



Rebated, single-leaf with glazing DIN LA

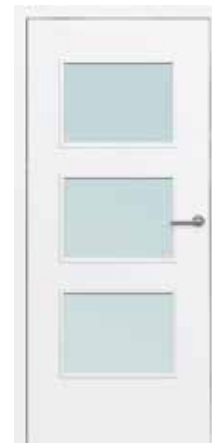

Flush, single-leaf with glazing LA 11



Flush, single-leaf



Flush, double-leaf



Flush, sliding door





**Duradecor**  
Extremely impact resistant



**4Protect**  
edge guard

**DURADecOR SMOOTH.** The extremely impact-resistant Duradecor surface finish is the right choice for your home. Whether elegant White lacquer, modern grey or cosy timber decors – you are sure to find a residential internal door to your taste. Our flush-closing doors and rebated doors with angular edges in the Duradecor surface finishes White lacquer, Light grey, Dusty grey, White Parchment, Light grey Parchment and White Ash are equipped with the high-quality 4Protect edge guard as standard.

→ Further information about the Duradecor surface finish and 4Protect edge guard can be found on page 9.

## COLOURS AND DESIGNS

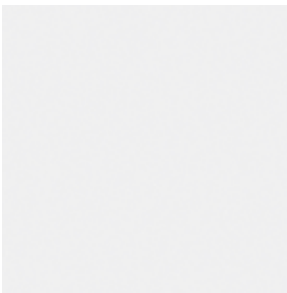

White lacquer RAL 9016

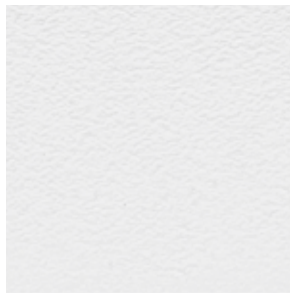

White Parchment

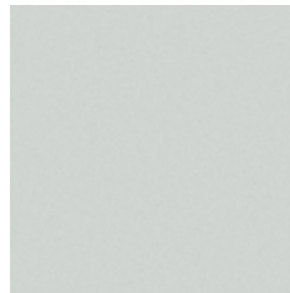

Light grey RAL 7035

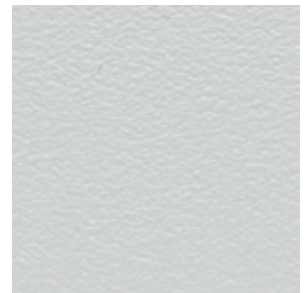

Light grey Parchment

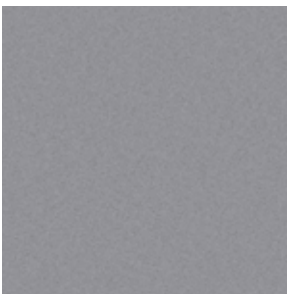

Dusty grey RAL 7037

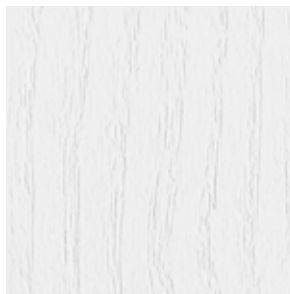

White Ash



Canadian Maple



French Beech

The colours and decors shown are subject to the limitations of the printing process and cannot be regarded as binding.  
**Please consult with your local Hörmann sales partner.**

LEFT. Flush-closing timber door BaseLine, Duradecor Dusty grey RAL 7037, contrasting edge 4Protect in black, lever handle Linea Planar black.edition





**Duradecor**  
Extremely impact resistant



**4Protect**  
edge guard

**DURADecor TEXTURE.** This surface stylishly combines a feeling of real wood with ease of care. A wood grain texture is embossed into the door leaf, making the characteristic wood texture palpable. Flush-closing doors and rebated doors with angular edges in the Duradecor texture surface finish Brushed White are equipped with the high-quality 4Protect edge guard as standard.

→ Further information about the Duradecor surface finish and 4Protect edge guard can be found on page 9.

## DECORS



Grey Oak\*



White Oak\*



Wild Oak\*



Raw Oak\*



Brushed White\*



Brushed Pine



Italian Acacia



Brushed Salted Oak



Spanish Oak\*



Walnut

The decors shown are subject to the limitations of the printing process and cannot be regarded as binding. **Please consult with your local Hörmann sales partner.**

\* Also with vertical grain

LEFT. Flush-closing timber door BaseLine, Duradecor Wild oak with vertical grain, contrasting edge 4Protect in black, lever handle Linea Planar black.edition





**Vibrant colour coating**



**RAL to choose**

**REAL LACQUER.** Timber doors with lacquered surfaces have a classic and high-quality effect. The even coating of the entire door set – frame and door leaf with a white Duradecor base plate – ensures a uniform surface, a seamless edge transition as well as a rich, vibrant colour. For a custom residential internal door, you can choose from all RAL colours. Design your home just how you like it!

## PREFERRED COLOURS



Traffic white RAL 9016



Pure white RAL 9010



Light grey RAL 7035

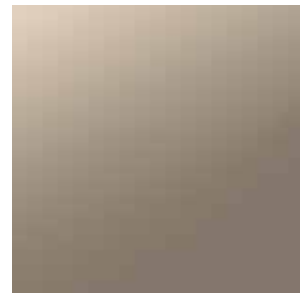

Taupe RAL 7048



Dusty grey RAL 7037



Anthracite grey RAL 7016



Jet black RAL 9005

The colours shown are subject to the limitations of the printing process and cannot be regarded as binding. **Please consult with your local Hörmann sales partner.**

LEFT. Flush-closing timber door BaseLine, real lacquer Traffic white RAL 9016, lever handle Linea matt stainless steel







**Vibrant colour  
coating**

**REAL LACQUER MATT. NEW.** Timber doors with a matt lacquered surface finish are a current trend in high-quality interior design. We have developed our new matt lacquered preferred colours precisely for this purpose. They refine modern interiors and provide for a markedly stylish ambience. The perfectly processed surface finish with an even coating and a seamless edge transition radiates simple elegance.

## PREFERRED COLOURS



Traffic white RAL 9016

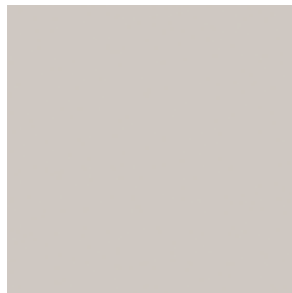

Pure white RAL 9010



Light grey RAL 7035



Taupe RAL 7048



Dusty grey RAL 7037



Anthracite grey RAL 7016



Jet black RAL 9005

The colours shown are subject to the limitations of the printing process and cannot be regarded as binding.  
**Please consult with your local Hörmann sales partner.**



**REAL WOOD VENEER.** Natural, cosy, unique – Hörmann real wood veneers are produced from high-quality real timber and are truly unique.

**VENEERS**



Maple\*



Beech\*



American Oak\*



Knotted Oak\*



American Walnut\*



Ash



Limba



Paintable Limba



Mountain Oak



Oiled Oak in stressed timber



Matt lacquer Alpine Oak



Stained Oak



Macore



Mahogany

The veneers shown are subject to the limitations of the printing process and cannot be regarded as binding. **Please consult with your local Hörmann sales partner.**

\* Also with vertical grain

LEFT. Rebated timber door BaseLine, real wood veneer Knotted Oak with vertical grain, lever handle Linea matt stainless steel



# DesignLine Concepto





**Duradecor**  
Extremely impact resistant



**4Protect**  
edge guard

DesignLine Concepto is the perfect choice for a modern interior design style. Five trend colours meet three elegant Duradecor surfaces, allowing you to realise impressive individual room concepts in your own home – and extremely stylishly. All door versions are equipped with the high-quality 4Protect edge guard as standard.

#### Door versions

-  Rebated with rounded edges\*
-  Rebated with angular edges
-  Flush

→ Further information about the Duradecor surface finish and 4Protect edge guard can be found on page 9.

\* Not for Slate surface finish

## SURFACES

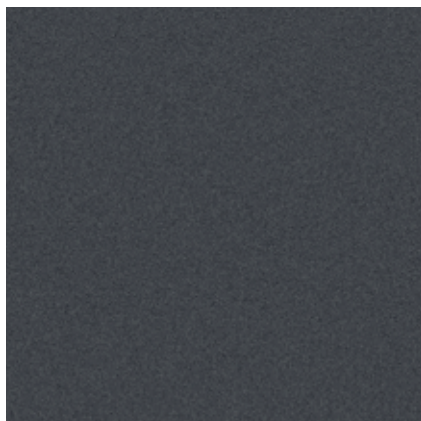

#### Ultra matt

The particularly elegant silk matt surface finish meets the highest demands both visually and haptically. Ultra matt combines high resistance to fingerprints and soiling with a previously unattainable matt finish.

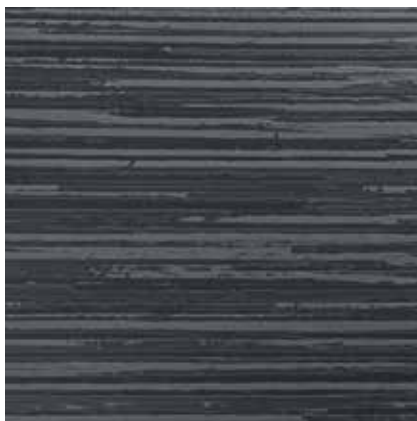

**Only from Hörmann**

#### Slate

We recommend this textured surface finish for a modern yet cosy interior design. The light-shadow contrast on the raised texture gives it a very pleasant and natural appearance. This variant is also available as a glass door.



#### Linen

With its fine, tangible structure, the Linen surface finish blends particularly well with wood shades and suits a sophisticated, rustic-modern decorative style. At the same time, the surface is robust and easy-to-clean. The Linen surface finish is also available to choose as a glass door.

LEFT. Flush-closing timber door DesignLine Concepto, Slate Dusty grey RAL 7037, lever handle Linea black.edition

The surface finishes shown are subject to the limitations of the printing process and cannot be regarded as binding. **Please consult with your local Hörmann sales partner.**

## Traffic white



**DesignLine Concepto**  
Ultra matt



**DesignLine Concepto**  
Slate



**DesignLine Concepto**  
Linen



**ConceptoGlass**  
Slate



**ConceptoGlass**  
Linen

## Light grey



**DesignLine Concepto**  
Ultra matt



**DesignLine Concepto**  
Slate



**DesignLine Concepto**  
Linen



**ConceptoGlass**  
Slate



**ConceptoGlass**  
Linen

## Dusty grey



**DesignLine Concepto**  
Ultra matt



**DesignLine Concepto**  
Slate



**DesignLine Concepto**  
Linen



**ConceptoGlass**  
Slate



**ConceptoGlass**  
Linen

RIGHT. Recessed timber door DesignLine Concepto, Linen, Anthracite, lever handle Karee black.edition and glass door ConceptoGlass, Linen, Anthracite, fitting set Purista black.edition

## Anthracite



DesignLine Concepto  
Ultra matt



DesignLine Concepto  
Slate



DesignLine Concepto  
Linen



ConceptoGlass  
Slate



ConceptoGlass  
Linen

## Taupe



DesignLine Concepto  
Ultra matt



DesignLine Concepto  
Slate



DesignLine Concepto  
Linen



ConceptoGlass  
Slate



ConceptoGlass  
Linen

The surface finishes and colours shown are subject to the limitations of the printing process and cannot be regarded as binding.  
**Please consult with your local Hörmann sales partner.**









# DesignLine Stripe 15

The Stripe style with embossed grooves offers you a tasteful design with a little something extra. Flush-closing doors and rebated doors with angular edges are equipped with the high-quality 4Protect edge guard as standard.



## Door versions

-  Rebated with angular edges
-  Flush

-  Duradecor smooth
-  White lacquer RAL 9016
-  Dusty grey RAL 7037

→ Further information about the surface finish and colours can be found in the BaseLine section starting on page 16.



**Stripe 15**  
Duradecor  
Dusty grey RAL 7037



**Stripe 15**  
Duradecor  
White lacquer RAL 9016



**Matching glass door**  
**GrooveGlass 15/5**  
Clear glass surface  
(single-pane safety glass)  
with matt style (silkscreen),  
stripe width 5 mm

LEFT: Rebated timber door DesignLine Stripe 15, Duradecor White lacquer, lever handle Linea matt stainless steel





# DesignLine Groove

**GROOVE.** The grooves milled into the door leaf and the high-quality paint finish make the Groove style an elegant eye-catcher. Matching all-glass doors are available for the DesignLine Groove styles for the perfect mix of timber and glass doors.









→ Further information about the surface finish and colours can be found in the BaseLine section starting on page 16.

## Door versions

-  Rebated with rounded edges
-  Rebated with angular edges
-  Flush

## Real lacquer / Real lacquer matt .NEW

-  Traffic white RAL 9016
-  Pure white RAL 9010
-  Light grey RAL 7035
-  Taupe RAL 7048
-  Dusty grey RAL 7037
-  Anthracite grey RAL 7016
-  Jet black RAL 9005
-  Choice of RAL (not for real lacquer matt)



**Groove 14**  
Real lacquer  
Traffic white RAL 9016



**GrooveGlass 14**  
Matt glass surface (single-pane safety glass, sand-blasted) with clear style



**GrooveGlass 14**  
Clear glass surface (single-pane safety glass) with matt style (sand-blasted)

LEFT. Rebated timber door DesignLine Groove 50, real lacquer Jet black RAL 9005, lever handle Linea matt stainless steel



**Groove 3**



**Groove 13**



**GrooveGlass 13**  
Clear glass surface  
(single-pane safety  
glass) with matt style  
(sand-blasted)



**Groove 15**



**GrooveGlass 15/5**  
Matt glass surface  
(single-pane safety  
glass, sand-blasted) with  
clear style, stripe width 5 mm



**Groove 20**



**GrooveGlass 20**  
Clear glass surface  
(single-pane safety  
glass) with matt style  
(V fluted glass)



**GrooveGlass 20**  
Matt glass surface  
(single-pane safety  
glass, sand-blasted)  
with clear style



**Groove 21**



**Groove 22**



**GrooveGlass 29**  
Clear glass surface  
(single-pane safety  
glass) with matt style  
(sand-blasted)



**GrooveGlass 29**  
Clear glass surface  
(single-pane safety  
glass) with matt style  
(sand-blasted)



**Groove 31**



**Groove 34**



**Groove 39**

All timber doors in real lacquer, Traffic white RAL 9016



**GrooveGlass 15/5**  
 Clear glass surface  
 (single-pane safety glass)  
 with matt style (silkscreen),  
 stripe width 5 mm



**Groove 16**



**GrooveGlass 16**  
 Clear glass surface  
 (single-pane safety glass) with matt style  
 (sand-blasted)



**Groove 18**



**Groove 19**



**Groove 23**



**GrooveGlass 23**  
 Clear glass surface  
 (single-pane safety glass) with matt style  
 (sand-blasted)



**GrooveGlass 23**  
 Matt glass surface  
 (single-pane safety glass, sand-blasted)  
 with clear style



**Groove 27**



**Groove 29**



**Groove 44**



**Groove 49**



**Groove 50**



**GrooveGlass 50**  
 Clear glass surface  
 (single-pane safety glass) with matt style  
 (sand-blasted)



**Groove 51**



**GrooveGlass 51**  
Matt glass surface  
(single-pane safety glass,  
silkscreen) with clear style



**Groove 53**



**Groove 54**



**Groove 55**



**Groove 56**



**Groove 78**



**Groove 85**



**GrooveGlass 85**  
Matt glass surface  
(single-pane safety  
glass, sand-blasted)  
with clear style



**Groove 86**



**Groove 87**



**Groove 88**



**Groove 89**



**Groove 92**



**Groove 93**

All timber doors in real lacquer, Traffic white RAL 9016

RIGHT. Rebated timber door DesignLine Groove 85, real lacquer Traffic white RAL 9016,  
lever handle Linea matt stainless steel









# DesignLine Steel

## DesignLine Plain

**STEEL.** The Steel style represents a modern design thanks to the surface-mounted embellishments in a stainless steel look.







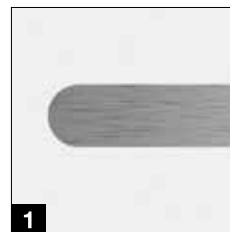

**PLAIN.** The Plain style creates elegant accents with inlaid and thus flush-fitting embellishments. For a modern and exclusive door design, you can choose from embellishments in 4 looks: stainless steel **1** and now in black **2**, bronze **3** or gold **4**.

### Door versions

-  Rebated with rounded edges
-  Rebated with angular edges
-  Flush







### Duradecor smooth

-  White lacquer RAL 9016
-  White Parchment
-  Light grey RAL 7035
-  Light grey Parchment
-  Dusty grey RAL 7037
-  White Ash
-  Canadian Maple
-  French Beech













### Duradecor ultra matt (Only for DesignLine Steel)

-  Traffic white RAL 9016
-  Light grey RAL 7035
-  Dusty grey RAL 7037
-  Anthracite grey RAL 7016
-  Taupe RAL 7048



### Duradecor texture

-  Grey Oak
-  White Oak
-  Wild Oak
-  Raw Oak
-  Brushed White
-  Brushed Pine
-  Italian Acacia
-  Brushed Salted Oak
-  Spanish Oak
-  Walnut



### Real lacquer/ Real lacquer matt .NEW

-  Traffic white RAL 9016
-  Pure white RAL 9010
-  Light grey RAL 7035
-  Taupe RAL 7048
-  Dusty grey RAL 7037
-  Anthracite grey RAL 7016
-  Jet black RAL 9005



Choice of RAL  
(not for real lacquer matt)

→ Further information about the surfaces, colours and decors can be found in the BaseLine section starting on page 16.

LEFT. Flush-closing timber door DesignLine Plain 27-7, Duradecor White lacquer, black embellishments, contrasting edge 4Protect in black, lever handle Linea black.edition



Steel 14 / Plain 14-7



Steel 16



Steel 20



Steel 23 / Plain 23-7



Steel 27 / Plain 27-7



Steel 29



Steel 37



Steel 38



Steel 39



Steel 78



Plain 27-7  
With black  
embellishments, door  
fittings black.edition



Matching glass door  
**Loft design 1-5**  
Clear glass surface  
(single-pane safety glass)  
with black style

All timber doors in Duradecor, White lacquer RAL 9016





# DesignLine Rail

**RAIL.** We recommend the timber and glass combination as the perfect complement to the DesignLine timber door styles.

→ Further information about the surfaces, colours and decors can be found in the BaseLine section starting on page 16.



**Rail 1  
Clear glass**  
Available in the glass types Clear and Clear White

**Rail 2  
Matt glass**  
Available in the glass types Satinato and silkscreen, solid



**Rail 1  
Design glass**  
Available in the glass styles Lines, Wave, Gropus matt, Gropus clear, Gisa, Jil, Raff, GrooveGlass 15 clear / matt (shown), GrooveGlass 29 clear / matt

→ Further information on the glass types can be found in the GlassLine section starting on page 54.

All doors in Duradecor, White lacquer RAL 9016









LEFT. Rebated timber glass door Rail 1, design glass GrooveGlass 15 clear / matt, Duradecor White lacquer, lever handle Linea matt stainless steel

## Door versions





-  Rebated with rounded edges
-  Rebated with angular edges
-  Flush













## Duradecor smooth

-  White lacquer RAL 9016
-  White Parchment
-  Light grey RAL 7035
-  Light grey Parchment
-  Dusty grey RAL 7037
-  White Ash
-  Canadian Maple
-  French Beech







## Duradecor ultra matt

-  Traffic white RAL 9016
-  Light grey RAL 7035
-  Dusty grey RAL 7037
-  Anthracite grey RAL 7016
-  Taupe RAL 7048

## Duradecor texture

-  Grey Oak
-  White Oak
-  Wild Oak
-  Raw Oak
-  Brushed White
-  Brushed Pine
-  Italian Acacia
-  Brushed Salted Oak
-  Spanish Oak
-  Walnut

## Real lacquer/ Real lacquer matt .NEW

-  Traffic white RAL 9016
-  Pure white RAL 9010
-  Light grey RAL 7035
-  Taupe RAL 7048
-  Dusty grey RAL 7037
-  Anthracite grey RAL 7016
-  Jet black RAL 9005

 Choice of RAL (not for real lacquer matt)













# ClassicLine Carolina

The panel frames are created by an embossed profile in the door leaf. The high-quality paint coating means you can enjoy a smooth, brilliant colour surface. These especially cost-effective designs in a classic style are only available in our standard sizes.



→ Further information about the surfaces, colours and decors can be found in the BaseLine section starting on page 16.

## Door versions

-  Rebated with rounded edges
-  **Real lacquer/ Real lacquer matt .NEW**
-  Traffic white RAL 9016
-  Pure white RAL 9010
-  Light grey RAL 7035
-  Taupe RAL 7048
-  Dusty grey RAL 7037
-  Anthracite grey RAL 7016
-  Jet black RAL 9005
-  Choice of RAL (not for real lacquer matt)



**Carolina 1**



**Carolina 1**  
With glazing cut-out  
LA rail 2 / 3



**Carolina 1**  
With glazing cut-out  
Lugano



**Carolina 2**



**Carolina 4**



**Carolina 4**  
With glazing cut-out  
LA rail 2 / 3



**Carolina 5**

All doors in Lacquer, Traffic white RAL 9016

LEFT. Rebated timber door ClassicLine Carolina 1, real lacquer Traffic white RAL 9016, lever handle Linea matt stainless steel





# ClassicLine Georgia

The high-quality profile strip is inlaid into grooves in the door leaf using traditional carpentry techniques, lending these styles a very elegant appearance that is the perfect match to classic interior styles.

→ Further information about the surfaces, colours and decors can be found in the BaseLine section starting on page 16.



Georgia 1



Georgia 2  
With glazing cut-out



Georgia 3



Georgia 4





Georgia 4  
With glazing cut-out











Georgia 5

## Door versions

-  Rebated with rounded edges
-  Rebated with angular edges
-  Flush







## Duradecor smooth

-  White lacquer RAL 9016
-  White Parchment
-  Light grey RAL 7035
-  Light grey Parchment
-  Dusty grey RAL 7037
-  White Ash
-  Canadian Maple
-  French Beech









## Duradecor texture

-  White Oak
-  Wild Oak
-  Brushed White
-  Brushed Pine
-  Brushed Salted Oak



## Real lacquer/ Real lacquer matt .NEW

-  Traffic white RAL 9016
-  Pure white RAL 9010
-  Light grey RAL 7035
-  Taupe RAL 7048
-  Dusty grey RAL 7037
-  Anthracite grey RAL 7016
-  Jet black RAL 9005



Choice of RAL  
(not for real lacquer matt)

All doors in Lacquer, Traffic white RAL 9016

LEFT. Rebated timber door ClassicLine Georgia 2, real lacquer Taupe RAL 7048, lever handle Vallis matt stainless steel



# ClassicLine Montana

The high-quality finish of the frame look emphasises the simple elegance. The reduced design language matches both a classic and modern interior style.

→ Further information about the surfaces, colours and decors can be found in the BaseLine section starting on page 16.



## Door versions



Rebated with angular edges



**Real lacquer/  
Real lacquer matt .NEW**



Traffic white RAL 9016



Pure white RAL 9010



Light grey RAL 7035



Taupe RAL 7048



Dusty grey RAL 7037



Anthracite grey RAL 7016



Jet black RAL 9005



Choice of RAL  
(not for real lacquer matt)



**Montana 1**  
With glazing cut-out



**Montana 2**



**Montana 3**



**Montana 4**  
With glazing cut-out



**Montana 5**



**Montana 6**  
With glazing cut-out



**Montana 7**  
With glazing cut-out



**Montana 8**

All doors in Lacquer, Traffic white RAL 9016

LEFT: Rebated timber door ClassicLine Montana 4, real lacquer Traffic white RAL 9016, lever handle Linea black.edition



# ClassicLine Kontura

The 46-mm-thick door leaf is particularly charming thanks to its contour-milled profiles in combination with a slight V-groove, which blends in perfectly not only with older flats.

→ Further information about the surfaces, colours and decors can be found in the BaseLine section starting on page 16.





## Door versions

 Rebated with rounded edges

## Real lacquer/ Real lacquer matt .NEW

 Traffic white RAL 9016

 Pure white RAL 9010

 Light grey RAL 7035

 Taupe RAL 7048

 Dusty grey RAL 7037

 Anthracite grey RAL 7016

 Jet black RAL 9005

 Choice of RAL (not for real lacquer matt)



**Kontura 1**  
With glazing cut-out  
LA 2 1



**Kontura 2**



**Kontura 3**  
With glazing cut-out LA



**Kontura 4**  
Rail 1 / 3



**Kontura 5**



**Kontura 6**  
With glazing cut-out  
LA 2



**Kontura 7**



**Kontura 12**

All doors in Lacquer, Traffic white RAL 9016

LEFT: Rebated timber door ClassicLine Kontura 4, real lacquer Jet black RAL 9005, lever handle Linea matt stainless steel



# GlassLine

**MORE LIGHT FOR YOUR HOME.** With the doors of GlassLine you enjoy numerous glass-clear advantages: Glass doors are elegant and chic. They give your home an open feeling and each room a very special charm. GlassLine is also particularly easy to clean: All styles with sand-blasted glass feature nano coating. Your benefit: You see fewer fingerprints!



**Laser technique**  
This glass finish offers fine details and shading. The depth effect creates fascinating impressions that are further enhanced by the brilliance of the glass door.



**Sand-blasting**  
If you value individuality: The sandblasting technique draws delicate designs in the glass surface. The matt surface finish with nano coating guarantees fewer fingerprints.



**Silkscreen**  
Design meets the highest quality surface embellishment: The particularly scratch-resistant surface is easy to clean and resistant to soiling.



**Fluted glass**  
The fluted glass on the glass door is created by a fine V-groove. A clear or satin-finished glass is used depending on the preferred opaqueness. The fluted glass impresses with special patterns, its tactile feel and the extraordinary play of light produced by the prism effect.

**Tip** Fewer fingerprints thanks to nano coating

**Tip** Particularly easy to clean



**Glass type Clear**  
With this glass type, the glass door creates a subtle, interesting contrast. The iron oxide in the glass produces a slight "green shimmer".



**Glass type Clear White**  
The Clear White glass type provides for a nearly colour-neutral view.



**Single-pane safety glass**  
All glass doors with styles feature 8-mm-thick single-pane safety glass. This glass type is also available in tinted or solid matt versions, as well as in a cool loft design.



**Laminated safety glass**  
This 10-mm-thick glass type consists of 2 panes that are firmly connected with a colour or matt plastic film.

LEFT. Glass door Gropus , fitting set Aronda Combi, matt stainless steel, lever handle Linea matt stainless steel



**Agesa**  
Clear glass surface (single-pane safety glass) with matt style (laser technology)



**Amra**  
Clear glass surface (single-pane safety glass) with matt style (sand-blasted)



**Batista**  
Clear glass surface (single-pane safety glass) with matt style (silkscreen)



**Corbus**  
Clear glass surface (single-pane safety glass) with matt style (sand-blasted)



**Corbus**  
Matt glass surface (single-pane safety glass) with clear style



**Jada**  
Clear glass surface (single-pane safety glass) with matt style (sand-blasted)



**Jil**  
Clear glass surface (single-pane safety glass) with matt style (sand-blasted)



**Jil**  
Matt glass surface (single-pane safety glass, sand-blasted) with clear style



**Liko**  
Clear glass surface (single-pane safety glass) with matt style (sand-blasted)



**Liko**  
Matt glass surface (single-pane safety glass, sand-blasted) with clear style



**Milton**  
Clear glass surface (single-pane safety glass) with matt style (sand-blasted)



**Milton**  
Matt glass surface (single-pane safety glass, sand-blasted) with clear style



**Nubia**  
Matt glass surface (single-pane safety glass, sand-blasted) with clear style



**Pinta**  
Clear glass surface (single-pane safety glass) with matt style (sand-blasted)



**Privat**  
Matt glass surface (single-pane safety glass, sand-blasted) with clear style as desired





**Graphic**  
Clear glass surface  
(single-pane safety  
glass) with matt style  
(sand-blasted)



**Graphic**  
Matt glass surface  
(single-pane safety  
glass, sand-blasted)  
with clear style



**Gropus**  
Clear glass surface  
(single-pane safety glass)  
with style (fluted glass)



**Gropus**  
Matt glass surface  
(single-pane safety  
glass, Satinato)  
with style (fluted glass)



**Lines**  
Clear glass surface  
(single-pane safety  
glass) with matt style  
(laser technology)



**Lito**  
Clear glass surface  
(single-pane safety  
glass), with matt text  
(laser technology)



**Meda**  
Matt glass surface  
(single-pane safety  
glass, sand-blasted)  
with clear style



**Memory**  
Clear glass surface  
(single-pane safety  
glass) with matt style  
(sand-blasted)



**Memory**  
Matt glass surface  
(single-pane safety  
glass, sand-blasted)  
with clear style



**Raff**  
Clear glass surface  
(single-pane safety glass,  
sandblasting, optionally in  
silkscreen) with matt style



**Raff**  
Matt glass surface  
(single-pane safety  
glass, sand-blasted)  
with clear style



**Rika**  
Clear glass surface  
(single-pane safety glass)  
with matt style (silkscreen)



**Wave**  
Clear glass surface  
(single-pane safety  
glass) with matt style  
(sand-blasted)



**Wave**  
Matt glass surface  
(single-pane safety glass,  
sand-blasted, optionally in  
silkscreen) with clear style



**Wildlife**  
Clear glass surface  
(single-pane safety  
glass) with matt style  
(sand-blasted)



**Wildlife**  
Matt glass surface  
(single-pane safety  
glass, sand-blasted)  
with clear style



**Yoko**  
Matt glass surface  
(single-pane safety  
glass) with clear style (silkscreen)



**Clear**  
Clear glass surface  
(single-pane safety  
glass or laminated safety  
glass with plastic film  
inside)



**Clear bronze**  
Tinted glass surface  
(single-pane safety  
glass)



**Clear grey**  
Tinted glass surface  
(single-pane safety  
glass)



**Dark grey**  
Tinted glass surface  
(single-pane safety  
glass)



**Master-Carré**  
Glass surface  
(single-pane safety  
glass, Master-Carré)



**Solid silkscreen**  
Solid mat glass surface  
(single-pane safety  
glass, silkscreen)



**Satinato**  
Matt glass surface  
(single-pane safety  
glass, Satinato)



**Satinato look**  
Matt glass surface  
(laminated safety  
glass with plastic film  
inside)



**White**  
Glass surface (laminated  
safety glass) with  
coloured plastic film  
inside



**Black**  
Glass surface (laminated  
safety glass) with  
coloured plastic film  
inside



**Loft design 1-5**  
Clear glass surface  
(single-pane safety  
glass) with black  
style



**Loft design 2-5**  
Clear glass surface  
(single-pane safety  
glass) with black  
style

RIGHT. Glass door loft design 2-5, fitting set Purista Combi black.edition, lever handle Linea black.edition, sliding door Slide Compact with glazed side element, profile black.edition, recessed lever handle 6402 black.edition





# Steel loft doors

**INDUSTRIAL STYLE FOR LIVING SPACES AND WORKSPACES.** You value timeless elegance and modern minimalism? If so, our loft doors are perfect for you. Their harmony with steel and glass gives your interior design a special touch. The loft doors are available up to a door set size of 5000 × 4000 mm! Doors in this size are also very elegant thanks to their narrow profile view of 76 mm (door) and 20 mm (fixed glazing) and the surface-mounted rails.

You can optionally equip the doors with angled glazing beads or the Slim glazing bead. Choose between Jet black RAL 9005 or stainless steel for your door fittings.



Further information can be found in the "Steel loft doors" brochure.



TOP. Profile with glazing bead Slim (standard), viewed width 15 mm  
CENTRE. Profile with angled glazing bead (optional), viewed width 50 mm  
BOTTOM. Lever handle in Jet black RAL 9005

LEFT. Double-leaf steel loft door with transom light, Jet black RAL 9005, angled glazing beads, lever handle Ogro design model 8155 V, Jet black RAL 9005



**TIMELESS DESIGN.** With the loft doors, you create a modern, subtle connection between multiple rooms while also providing them more light. The filigree steel profile gives the design a modern line and a light appearance, while the glass adds to this overall elegant effect.





TOP LEFT. Double-leaf hinged door with optional rails

TOP RIGHT. Single-leaf hinged door with side elements, transom light and optional rails

BOTTOM: Double-leaf sliding door with side elements





# Sliding doors

Our compact solutions open up new possibilities for ideal use of your living space. Hörmann offers single-leaf and double-leaf sliding doors for all BaseLine, DesignLine, ClassicLine and GlassLine doors.

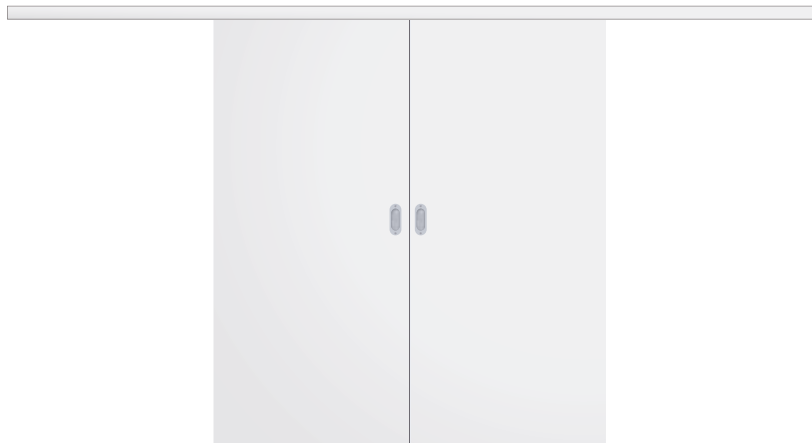

Double-leaf sliding door, type A, running in front of the wall



Single-leaf sliding door, type B, running in front of the wall



Single-leaf sliding door, type C, running in front of the wall

LEFT. Timber frame type C, running in front of the wall, Duradecor textured Grey oak, bar handle Basic round stainless steel



**TIMBER SLIDING DOOR FRAMES.** When fitted in front of the wall, the door leaf slides on two tracks mounted in the sliding door box. Timber sliding door frames are available in door version type A, B or C with vertical stop. Frame, sliding door box and door leaf with Duradecor, real lacquer or real wood veneer surface finish create a harmonious whole. When fitted running within the wall, the tracks are fitted in an on-site door pocket in the wall. This eliminates the sliding door box.

**STEEL SLIDING DOOR FRAMES.** The complete door set with vertical stop can be fitted in front of or running within the wall. The robust frames are supplied with a high-quality powder coating. For fitting in partition walls, we recommend the version with box design. The entire sliding door system is fitted as a unit and only has to be cladded with gypsum board. Especially elegant in version HW-SL with a frame face of only 6 mm (top left figure).

→ Further information can be found starting on page 88.



TOP LEFT. Steel frame HW-SL in box design, running in the wall, door leaf DesignLine Concepto Slate, Traffic white RAL 9016, bar handle Basic angular stainless steel

TOP RIGHT. Steel frame, running in front of the wall, door leaf BaseLine Duradecor White lacquer, bar handle Basic round stainless steel

BOTTOM RIGHT. Timber frame type C, running in front of the wall, door leaf ClassicLine Georgia 1 Duradecor White lacquer, bar handle Basic round stainless steel



**SLIDING DOOR SYSTEM ROTAN.** In this trendy industrial-style sliding door system, the door leaves are mounted on support brackets that slide over rollers on a track rail. The stainless steel rail is fitted to the wall.



TOP LEFT. Sliding door Rotan, door leaf Satinato, bar handle Basic angular, stainless steel



TOP RIGHT. Slide Compact sliding door with glazed side element profile black.edition, Clear grey door leaf, Flat handle black.edition, fitting in the reveal

BOTTOM RIGHT. Sliding door Slide Compact with vertical stop, door leaf GrooveGlass 85, recessed lever handle 6402 stainless steel, fitting in front of the reveal





**SLIDING DOOR SYSTEM SLIDE COMPACT.** The track profile for the sliding door leaf is available in the surface finishes matt stainless steel, Jet black or White. The profile can be fitted both in front of the wall and in the reveal. With a glazed side element, the system presents a translucent, space-saving solution for wide passages. For a door leaf weight of up to 60 kg, the Slide Compact system is equipped with a SafeClose in order to gently close the door leaves.

→ Further information can be found starting on page 88.









# Function doors and accessories

**FOR MORE SECURITY AND CONVENIENCE.** Apartment entrance doors offer high acoustic insulation, reliable function even with different temperatures inside the rooms and in the hallway, as well as certified security. Choose from three equipment packages for added security and convenience. Fire-rated doors in different fire protection classes can be equipped with additional functions such as smoke protection, acoustic insulation or security depending on the requirements. Improve your everyday living comfort with innovative solutions such as the SmartKey radio door lock operator or the PortaMatic door operator.

→ Further information can be found starting on page 96.

## Climate and apartment entrance doors

	WET system 1*	WET system 2	WET system 3
 Climatic class 3	●	●	●
 Acoustic rating category 1	●		
 Acoustic rating category 2		●	
 Acoustic rating category 3		●	●
 RC 2 security features		○	○
 RC 3 security features			●

● = Standard equipment ○ = Optional equipment

\* Only BaseLine

LEFT. Rebated apartment entrance door WET 3 BaseLine, Duradecor White lacquer, protective fitting matt stainless steel



**DOOR LOCK OPERATOR SMARTKEY.** Easily open your door lock at a press of a button with your radio hand transmitter, radio internal push button or directly via the sensor field on the SmartKey. No need to set down your groceries in order to open your entrance and apartment door. Even with a walker, wheelchair or pram, it is much easier to enter your house or apartment because you can open the door from a distance. Locking takes place either by pressing a button or automatically after a specified period of time. This securely locks your door and provides protection against burglary.

→ Further information can be found on page 97.



**DOOR OPERATOR PORTAMATIC.** Open and close your residential internal doors easily and automatically via radio hand transmitter or button. Whether you are physically disabled or would simply like more convenience – this technology will make your everyday life easier. The door operator PortaMatic not only features an array of functions and settings but also minimal power consumption. In addition, the PortaMatic is up to 25% cheaper than similar door operators and can be subsidised up to 100% by your nursing care insurance.



Further information can be found in the "Door operators" brochure.



Find out more about support options at [www.hormann.co.uk/home-owners-and-renovators/operators/internal-door-operators](http://www.hormann.co.uk/home-owners-and-renovators/operators/internal-door-operators)





76



78



88



# Design. Equipment. Accessories.

- 76 Door and frame design
- 78 Door fittings black.edition
- 79 Door fittings and lever handle sets for timber doors
- 84 Door fittings and lever handle sets for glass doors
- 86 Glazing cut-outs, side elements, transom lights
- 88 Door fittings and lever handle sets for sliding doors
- 90 Door and frame types
- 93 Steel frame VarioFix
- 94 Overview table
- 96 Function doors
- 98 Dimensions and fitting data for timber doors

# Door and frame design

Premium carpenter quality for high demands



**Attractive appearance with precision-fit and installation-friendly corner joints <sup>1</sup>**

### Jamb lining

- Screwed corner joints with jamb lining connection
- Easily readjustable
- Strong friction locking

### Cladding

- Solid-metal screw connectors
- Excellent friction locking
- Direct pressure distribution on the connection surfaces
- No visible drilled holes in the cladding

**High form stability thanks to the robust frame construction <sup>2</sup>**

- Jamb lining 25 mm thick
- Jamb lining with Duradecor surface finish
- Melamine-coated backing
- Claddings made of MDF
- Wall edge 23 mm
- Cladding 60 mm or optionally 70 mm

**Permanently quiet closing thanks to a high-quality seal <sup>3</sup>**

- Two-chamber system
- Clean contact with the door leaf
- Good absorbing properties

**Robust standard lock plate for added security <sup>4</sup>**

- Movable backfill
- Secured with six screws
- Double-turn locking
- Retrofit kits available

**Hybrid hinge pocket prevents lowering of the door <sup>5</sup>**

- Carrying capacity 80 kg
- Reinforced metal plastic mount
- Four-point screw connection in jamb lining
- Guiding sleeves extending to front edge of cladding
- For timber and glass doors

**High stability thanks to door leaf with frame reinforcement <sup>6</sup>**

- Internal doors with 80 mm frame reinforcement
- On hinge side and lock side



# Door fittings black.edition

In elegant Jet black

For design lovers, we recommend the door fittings in elegant Jet black. In contrast with white or grey surface finishes, our **black.edition** gives your door an exclusive touch.

Only from Hörmann

All door fittings  
in black.edition

## 4Protect contrasting edge

→ Further information can be found starting on page 90.

## Frame seal

## Door hinges

→ Further information can be found on page 79.

## Lever handle set

→ Further information can be found starting on page 80.

## Lock plate and lock cover

→ Further information can be found on page 79.

## Sliding door fittings



## Glass door fittings

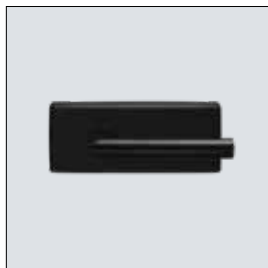

→ Further information can be found starting on page 84.



## Door fittings for rebated door leaves



Deadlock, Class I, lock cover in nickel silver (as standard)



2-part hinge V 3420 WF (standard)



2-part hinge V 3420 WF black.edition in Jet black (optional)



3-part hinge V 4426 WF (optional)



3-part hinge V 4426 WF black.edition in Jet black (optional)



3-way adjustable hinge VX 160-18 (optional)



Concealed hinge Pivota FX 2 60 3D (optional)

## Door fittings for flush-closing door leaves



Deadlock, Class I, lock cover in nickel silver (as standard)



Magnetic catch lock to gently and quietly close the door (optional), also available in the black.edition



Magnet catch lock with short lock cover for a discreet door view (optional), also available in the black.edition



Magnet catch lock black.edition in Jet black



Euro hinge concealed 3-way AN (optional)



Euro hinge concealed 3-way AN black.edition in Jet black (optional)



Concealed 3-way adjustable hinge DX 61 (optional)



3-part guide roller hinge V 7888 WF, 3-way adjustable (optional, only for timber frame)

# Lever handle sets

for timber doors



**Ala**  
Matt stainless steel  
S P



**Apart**  
Matt stainless steel  
S P



**Arundo**  
Matt stainless steel  
S P



**Basica 2**  
Matt stainless steel  
S P



**Basica 3**  
Matt stainless steel  
S P



**Indra**  
Polished stainless steel  
matt  
S F

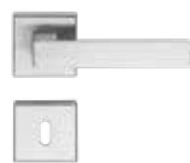

**Karee**  
Matt stainless steel  
S



**Lilet**  
Polished stainless steel,  
White porcelain handle  
S



**Linea**  
Matt stainless steel  
S F P



**Linea**  
Polished stainless steel  
F

 Optionally also for  
fire-rated doors



**Quadriga**  
Matt stainless steel  
S



**Tento**  
Matt stainless steel  
S P



**Vallis**  
Matt stainless steel  
S P



**Vento**  
Matt stainless steel  
S P



**Karee black.edition**  
Jet black matt  
S F



**Linea black.edition**  
Jet black matt  
S F P





**Dee**  
Matt stainless steel  
**S P**

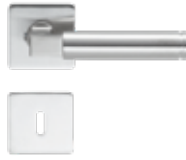

**Dee**  
Matt stainless steel  
**S**



**Linea**  
Matt stainless steel  
**S F**



**Luba**  
Matt stainless steel  
**S P**

### Variants for lever handle and lock rose escutcheons

Lever handle and lock sets are a defining element for the overall appearance of your residential internal door. Hörmann offers different variants of the lever handle sets shown:

**S STANDARD ROSE ESCUTCHEON.** The approx. 10-mm-thick lever handle and lock rose escutcheons are surface-mounted on the door leaf.

**F FLAT ROSE ESCUTCHEON.** This flat rose escutcheon shape adds just 3 mm, resulting in an elegant door view.

**P PLANAR.** Perfectly inset in the door leaf, the absolutely flush-fitting Planar rose escutcheons especially impress fans of design.

Another fine detail: The omission of the drilled key hole means the design looks even more minimalistic and therefore more elegant.



**S**



**F**



**P**

# Lever handle sets

for timber doors

## Bi-colour system 162



Matt black / matt bronze

F



Matt black / matt gold

F

## Bi-colour system 250



Matt black / matt bronze

F



Matt black / matt gold

F



Matt white / matt bronze

F

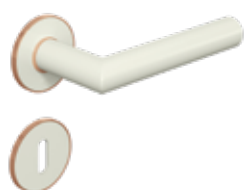

Matt white / matt gold

F

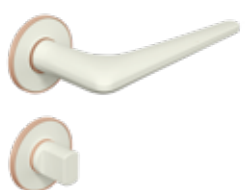

Matt white / matt bronze

F



Matt white / matt gold

F



Anthracite / matt stainless steel

F



Anthracite / matt stainless steel

F

F Flat rose escutcheon  
Further information can be found  
on page 79.



### Bi-colour lever handle sets

Give your timber doors an even more individual appearance with the lever handles from our Bi-colour system. Colour lever handles are combined with rose escutcheons for an elegant contrasting look. An unusual design element setting fine accents.



**Leaf Light**

Cashmere grey (see figure) or stainless steel, matt

**S**



**Remote**

Cashmere grey (see figure) or stainless steel, matt

**S**



**Avus One**

Cashmere grey (see figure) or stainless steel, matt, no rose escutcheon, optionally with Smart2Lock door lock on the handle

**S**

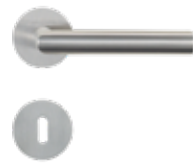

**Lucia**

Stainless steel matt (see figure) or Jet black matt (only Lucia Professional), optionally with Smart2Lock for locking the door at the handle

**S**

Lucia Professional

**F**

Lucia PiattaS

**S**

Standard rose escutcheon

**F**

Flat rose escutcheon

Further information can be found on page 79.



**Smart2Lock lock**

The locking mechanism is elegantly integrated into the lever handle and can be locked and unlocked with one hand. When locked, the lever handle can no longer be pressed down from outside or inside. Thanks to this intelligent locking technology, the key rose escutcheon is no longer necessary, giving your residential internal door an even more minimalist, elegant look.

# Door fittings and lever handle sets

for glass doors



**Aronda Combi fitting set**  
Matt stainless steel,  
polished stainless steel or EV1



**Fitting set Purista Combi**  
Matt stainless steel,  
polished stainless steel or EV1



**Fitting set Conica Combi**  
Matt stainless steel or EV1



**Mina Combi fitting set**  
Matt stainless steel, special glass  
door version required



**Apart**  
Matt stainless steel or  
polished / matt stainless steel



**Basica 3**  
Matt stainless steel or EV1



**Belis**  
Matt stainless steel



**Dee**  
Matt stainless steel,  
polished stainless steel or EV1



**Linea**  
Matt stainless steel,  
polished stainless steel or EV 1



**Nala**  
Matt stainless steel or  
polished stainless steel



**Quadriga**  
Matt stainless steel



## Increased acoustic insulation

Do you want quiet, bright living spaces and workspaces? Then we recommend the optional equipment for revolving glass doors Clear and Satinato with 11 mm laminated safety glass and retractable bottom seal. Look forward to doors with an acoustic insulation value of up to 32 dB (corresponding to acoustic rating category SK 1).



**Fitting set Purista Combi, black.edition**  
Matt Jet black incl. magnetic catch lock



**Linea, black.edition**  
Jet black matt



**Karee, black.edition**  
Jet black matt



**Puristo S fitting set**  
Cashmere grey (see figure) or stainless steel, optionally with Smart2Lock for locking the door at the handle



**Leaf Light**  
Cashmere grey (see figure) or stainless steel



**Remote**  
Cashmere grey (see figure) or stainless steel



**Avus One**  
Cashmere grey (see figure) or stainless steel



### Smart2Lock lock

The locking mechanism is elegantly integrated into the door fitting and can be locked and unlocked with one hand. When locked, the lever handle can no longer be pressed down from outside or inside. Thanks to this intelligent locking technology, glass doors can be locked without a key.

# Glazing cut-outs / side elements / transom lights

for timber doors

## Glazing cut-outs for timber doors BaseLine and DesignLine Concepto



DIN



LA 5



LA 9



LA 10



LA 11



LA24 centre



LA 27



LA Pure

## Side elements (intel-high)



Single-leaf, 1 side element



Single-leaf, 2 side elements

## Transom lights (ceiling-high)



Single-leaf, 1 top part,  
alternatively also with  
transom light



Double-leaf, 1 transom light

## Glazings for glazing cut-outs

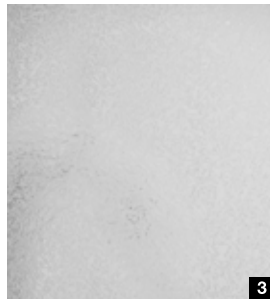
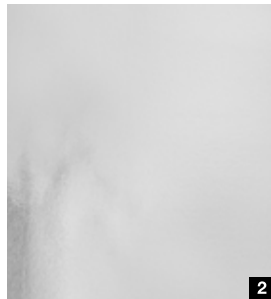

### Glass types

- 1 Artista clear
- 2 Chinchilla white
- 3 Frost flower glass white
- 4 Gothic white
- 5 Pave white
- 6 Master-Carré
- 7 Silvit 178 white
- 8 Uadi white
- 9 Clear laminated safety glass
- 10 Clear white laminated safety glass
- 11 Clear grey
- 12 Dark grey
- 13 Clear bronze
- 14 GrooveGlass 15/10, clear style
- 15 GrooveGlass 15/10 matt style

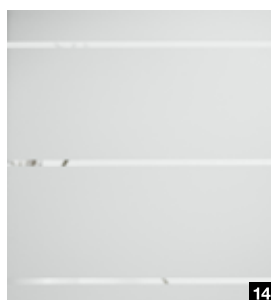
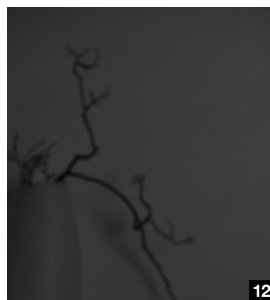
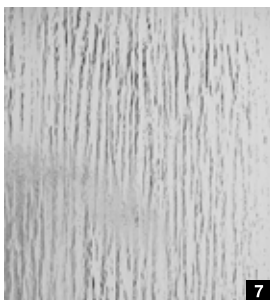
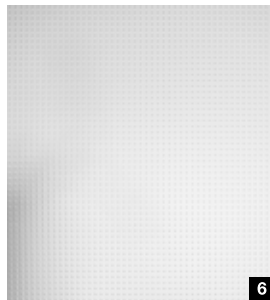
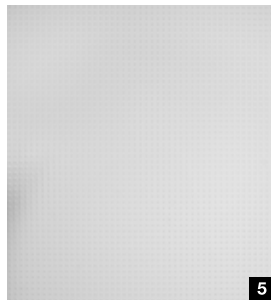
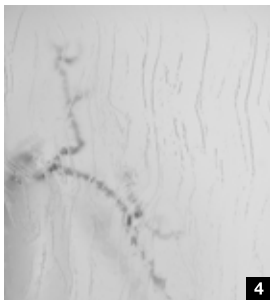

# Door fittings and lever handle sets

for sliding doors

## Slide Compact sliding door system



The profile of the sliding door system Slide Compact is supplied as standard in matt stainless steel (left figure) and optionally in matt Jet black (centre figure) or White (right figure).

Sliding door system Slide Compact with additional vertical stop (stainless steel colour) for single-leaf doors, running in front of the wall

## Sliding door system in the frame



With the brush on the door leaf (figure on left) and the inlet seal in the frame (figure on right), Hörmann sliding doors with frame type C running in front of the wall offer optimal protection against odours, noise and draughts – for even more comfort in your own home.

For sliding doors running within the wall, you can use a trip handle to release a door leaf completely concealed in the wall and close the door at the push of a button.



## Recessed handle for timber and glass doors



## Bar handles for timber and glass doors



# Door and frame types

Custom design and function



## Rebated version with round edges

If you value a harmonious overall design, you can't go wrong with this version: The door leaf rests on the frame and has rounded door leaf edges for a harmonious appearance. The rebated door view with round edges is available for all timber doors, except DesignLine Stripe and ClassicLine Montana.

## Rebated version with angular edges

If you appreciate a particularly streamlined look, then we recommend this version. The door leaf rests on the frame and has a beautifully designed, angular edge. It is available for all timber doors except for ClassicLine Carolina. In the Duradecor surface finishes with 4Protect edge guard and in the painted surface finish, this version impresses with a perfect seamless look.

## Flush version

Would you like an exclusive door view with a virtually flush-fitting transition to the frame? Then we recommend a flush-closing door leaf, which harmonises particularly well with a modern design. This version is available for all timber doors with the exception of ClassicLine Carolina. In the Duradecor surface finishes with 4Protect edge guard and in the real lacquer surface finish, this version impresses with a perfect seamless look.



4Protect edge guard



4Protect edge guard

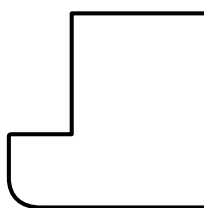

Horizontal view of door leaf

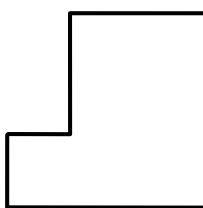

Horizontal view of door leaf

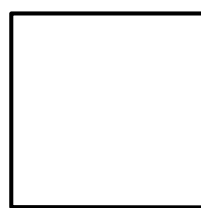

Horizontal view of door leaf



## 4Protect edge guard

The quadruple edge guard offers impressive features:

1. High impact resistance
2. High wear resistance
3. High scratch resistance
4. Seamless look, meaning that unlike conventional doors, no unsightly edge disturbs the high-quality door view.



Rebated version with angular edges



Flush version

## Contrasting edge 4Protect

The 4Protect contrasting edge in 6 colours gives timber doors with the Duradecor surface a special finishing touch.



Black



Anthracite



Dusty grey



White



Light grey

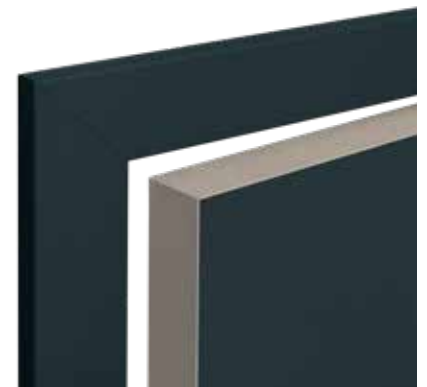

Taupe

# Door and frame types

Custom design and function

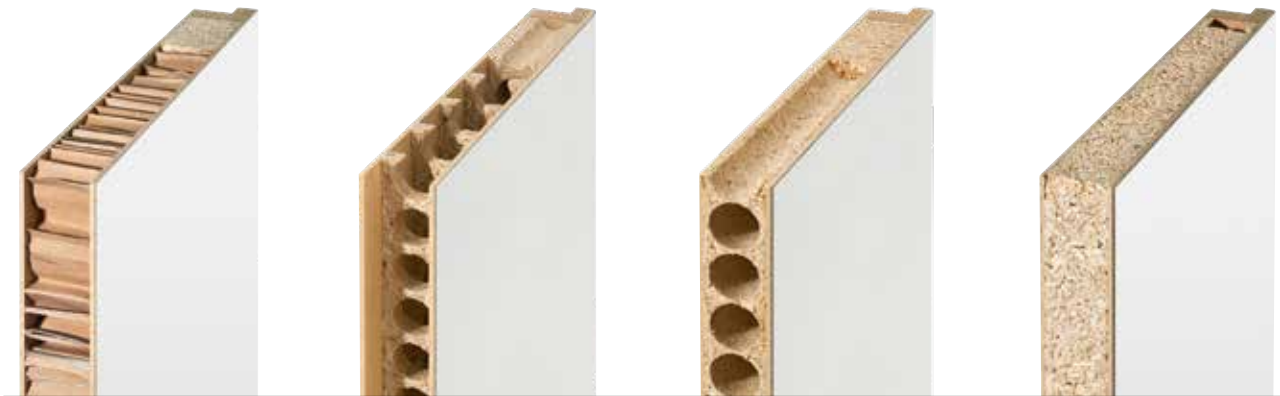

## Honeycomb insert

The honeycomb is a door inlay that retains its shape and has an excellent price-performance ratio.

## Tubular chipboard spacers

The door inlay consists of individual spacers that are arranged in the best possible layout. This means the door leaf is especially sturdy and suitable for heavy wear.

## Tubular chipboard plate

The solid plate with horizontal tubes gives the door leaves a high surface stability. These high-quality residential internal doors are suitable for even heavier wear.

## Solid chipboard

The high-quality solid chipboard door leaves have the highest leaf rigidity and are suitable for particularly heavy wear. Doors with glazing cut-outs are available with solid chipboard as standard.



## Profile frame

With rounded edges

## Profile frame

With angular edges  
(only for lacquer surface)

## Profile frame

With profile for ClassicLine  
Georgia and Carolina

## Block frame

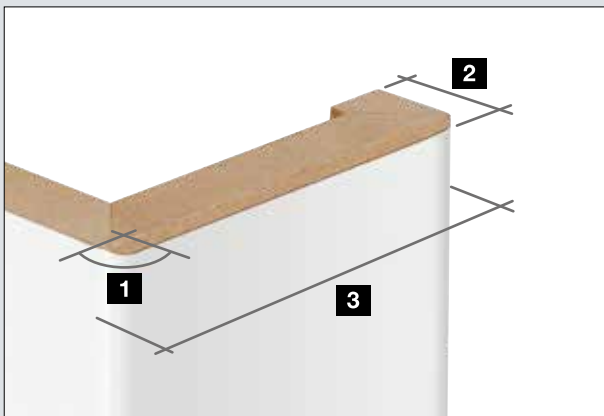

## Frame dimensions

- 1** Edge radius 3 mm
- 2** Wall edges
  - 16 mm
  - 23 mm
- 3** Cladding widths
  - 60 mm
  - 70 mm\*
  - 80 mm
  - 100 mm

\* Only available with 23 mm wall edge

# Steel frame VarioFix

The perfect combination of design, robustness and a long service life

## High-quality design

For the steel frame VarioFix, the corner joints feature high-quality welding and a flush polish, meaning there are no visible mitre cuts in the frame corners. In flush-closing doors, the robust construction guarantees a uniform gap dimension, as the frame can no longer warp after fitting.

## Ideal combination

The steel frame harmonises perfectly with other timber frames due to the frame face of 55 mm on both sides. To match our door leaves in Duradecor White lacquer and real lacquer Traffic white, the VarioFix frame is available in Traffic white RAL 9016 with a white sealing profile or in RAL as desired. The frame can be combined with glass or timber door leaves.

## Particularly long-lasting

Thanks to the high-quality powder coating, the frame can withstand run-ins with toy cars or vacuum cleaners, and any damage to the surface is easy to repair. Even cleaning water and a thorough washing cannot damage the frame.





















## Fast fitting

The VarioFix steel frame can be fitted to all wall types without screw fitting, using 2C foam, like a timber frame. This results in time savings of up to 50% during fitting compared with standard steel frames. Wall tolerances of up to 20 mm are no problem for the steel frame VarioFix. The adjustable decorative rebate easily compensates for different wall thicknesses during renovations and new construction projects.



# Overview table

for timber doors

Door styles									
		BaseLine	DesignLine Concepto	DesignLine Stripe 15	DesignLine Groove	DesignLine Steel	DesignLine Plain	DesignLine Rail	DesignLine Pure
<b>Surfaces</b>									
<b>Duradecor</b>									
Rebated angular		●	-	○	-	●	●	●	●
Rebated round		●	-	-	-	●	●	●	●
Flush angular		●	-	○	-	●	●	●	●
<b>Duradecor texture</b>									
Rebated angular		●	-	-	-	●	●	●	●
Rebated round		●	-	-	-	●	●	●	●
Flush angular		●	-	-	-	●	●	●	●
<b>Real wood veneer</b>									
Rebated angular		●	-	-	-	-	-	●	-
Rebated round		○	-	-	-	-	-	○	-
Flush angular		●	-	-	-	-	-	●	-
<b>Lacquer</b>									
Rebated angular		●	-	-	●	●	●	●	●
Rebated round		●	-	-	●	●	●	●	●
Flush angular		●	-	-	●	●	●	●	●
<b>Ultra matt</b>									
Rebated angular		-	●	-	-	●	-	-	-
Rebated round		-	●	-	-	●	-	-	-
Flush angular		-	●	-	-	●	-	-	-
<b>Slate</b>									
Rebated angular		-	●	-	-	●	●	-	-
Flush angular		-	●	-	-	●	●	-	-
<b>Linen</b>									
Rebated angular		-	●	-	-	●	●	-	-
Rebated round		-	●	-	-	●	●	-	-
Flush angular		-	●	-	-	●	●	-	-

● = Available for all decors / colours ○ = Not available for all decors / colours\*) With 46-mm-thick door leaf

Door inlay

ClassicLine Carolina ClassicLine Georgia ClassicLine Montana ClassicLine Kontura

Honeycomb insert Tubular chipboard spacers Tubular chipboard plate Solid chipboard

-	●	-	-	●	-	●	●
-	●	-	-	-	●	●	●
-	●	-	-	-	-	●	●
-	○	-	-	●	-	●	●
-	○	-	-	-	●	●	●
-	○	-	-	-	-	●	●
-	-	-	-	-	●	●	●
-	-	-	-	-	○	○	○
-	-	-	-	-	●	●	●
-	●	-	-	●	-	●	●
○	●	○	○*	-	●	●	●
-	●	-	-	-	●	●	●
-	-	-	-	-	-	●	●
-	-	-	-	-	-	●	●
-	-	-	-	-	-	●	●
-	-	-	-	-	-	●	●
-	-	-	-	-	-	●	●
-	-	-	-	-	-	●	●
-	-	-	-	-	-	●	●
-	-	-	-	-	-	●	●
-	-	-	-	-	-	●	●

# Function doors

for more security and convenience



## Climatic class 3

Doors in this class feature a special door leaf construction that balances the temperature and moisture differences between rooms with different uses, such as between an unheated cellar and a warm hallway.



## Acoustic insulation

Acoustic-rated doors are in demand in places where it can be very loud in apartments or offices. The connection between the door and frame is crucial here. It is an essential component for guaranteeing the required acoustic insulation.



## Security

Suitable special functions can significantly reduce the risk of burglary. Hörmann recommends resistance class RC 2 or, even better, RC 3 for apartment entrance doors.



## Fire protection

Fire protection can save lives! A suitably equipped door can protect against penetrating flames (for at least 30 or 90 minutes) as well as prevent the penetration of dangerous combustion gases. Fire-rated / smoke-tight door sets are only available as a complete package which includes the frame and all door fittings.

<sup>1)</sup> Depending on door width and fitting position







<sup>2)</sup> With RC 3: 2235 × 1110 mm

<sup>3)</sup> Only BaseLine, other door versions on request

<sup>4)</sup> Only for BaseLine, DesignLine Concepto, Groove, Steel, Plain and ClassicLine Kontura











<sup>5)</sup> Only for BaseLine Duradecor

## Climate and apartment entrance doors

	WET system 1 <sup>1)</sup>	WET system 2*	WET system 3
Door thickness approx.	40 mm	46 mm	52 mm
Max. dimensions	2110 × 985 mm	2235 × 1110 mm	2485 × 1235 mm <sup>3)</sup>
Linkage door closer	○	○	○
Slide rail door closer	○	○	○
VarioFix frame	○	○	○
 Climatic class 3	●	●	●
 Acoustic rating category 1	●		
 Acoustic rating category 2		●	
 Acoustic rating category 3		●	●
 RC 2 security features		○	○
 RC 3 security features			●

● = Standard equipment ○ = Optional equipment

## Fire-rated doors / smoke-tight doors

	Smoke-tight door <sup>3)</sup>	T30 / EI <sub>2</sub> 30 fire-rated door <sup>4)</sup>	T90 / EI <sub>2</sub> 90 fire-rated door <sup>5)</sup>
Door thickness approx.	46 mm	50 mm	70 mm
Max. dimensions	2235 × 1110 mm	2235 × 1235 mm	2485 × 1235 mm
Linkage door closer	○	●	●
Slide rail door closer	●	○	○
 T30 / EI <sub>2</sub> 30 fire-retarding		●	
 T90 / EI <sub>2</sub> 90 fire-proof			●
 Smoke protection	●	○	○
 Climatic class 2		●	●
 Climatic class 3	○	○	○
 Acoustic rating category 1	○	○	○
 Acoustic rating category 2	●	○	○
 Acoustic rating category 3	○	○	
 RC 2 security features	○	○	○
 RC 3 security features			○

● = Standard equipment ○ = Optional equipment





#### **Spyhole 1**

With an optional spyhole, you can see who is standing in front of your door at any time without having to open it.

#### **Electric strike 2**

With the optional electric strike catch, you can conveniently open your door via a switch inside the home.



#### **Lock equipment 3**

Optionally as a self-locking automatic lock or motor lock

#### **Protective fitting 4**

Optionally as long escutcheon / rose escutcheon ES 1 or long escutcheon / long escutcheon ES 2



#### **Linkage door closer 5**

As standard or optionally for single-leaf doors (depending on design)

#### **Slide rail door closer 6**

As standard or optionally for single- and double-leaf doors (depending on design)



#### **Fire protection lever 7**

(Profile cylinder not included in the scope of delivery) As standard in black plastic, or optionally as a stainless steel lever handle (see page 80).

#### **Radio door lock operator**

##### **SmartKey 8**

Available in white or silver, incl. radio hand transmitter HSE 4 SK BS with labelled buttons.

# Dimensions and fitting data

for timber doors

## Door leaf

- Approx. 40 mm thick
- Frame construction made of solid timber / timber material with additional frame reinforcement, can be shortened by 25 mm at bottom
- For double-leaf doors: with counter rebate\*
- Climatic class I, duty category N to S (depending on version)
- Ready-to-hang acc. to DIN 18101
- Suitable for timber profile frames or standard frames made of steel

## Frame

- Rebate cladding / decorative edge 16 × 60 mm, mitred and firmly glued to the jamb lining. 16 × 80 mm, 16 × 100 mm, 23 × 60 mm, 23 × 70 mm, 28 × 80 mm on request
- Jamb lining made of 25 mm chipboard, rebate cladding and decorative edge made of 12 mm MDF boards
- Wall thickness adjustable – 5 mm / + 15 mm bzw. – 5 / + 10 mm (for doors with real wood veneer)
- Seal inserted at the factory, mitred

## Vertical view

### Rebated

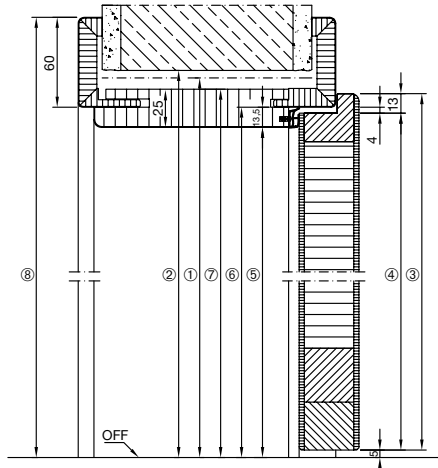

### Flush

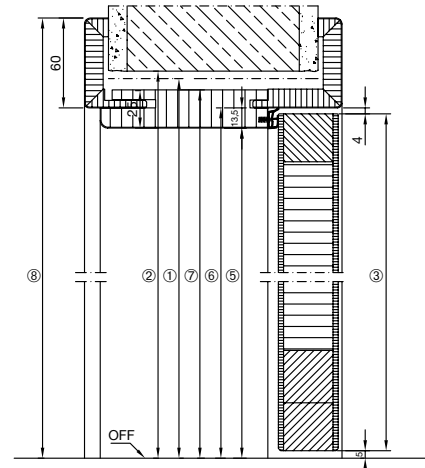

		1875	2000	2125	2250	
<b>1</b>	Nominal size height					
<b>2</b>	Wall opening	1880	2005	2130	2255	
<b>3</b>	Overall door leaf dimension	Rebated	1860	1985	2110	2235
		Flush	1847	1972	2097	2222
<b>4</b>	Leaf rebate dimension	1847	1972	2097	2222	
<b>5</b>	Clear passage dimension	1843	1968	2093	2218	
<b>6</b>	Frame hold dimension	1856	1981	2106	2231	
<b>7</b>	Overall lining dimension	1868	1993	2118	2243	
<b>8</b>	Overall frame dimension For 60 mm cladding (For 80 mm cladding + 20 mm)	1916	2041	2166	2291	

## Frame types

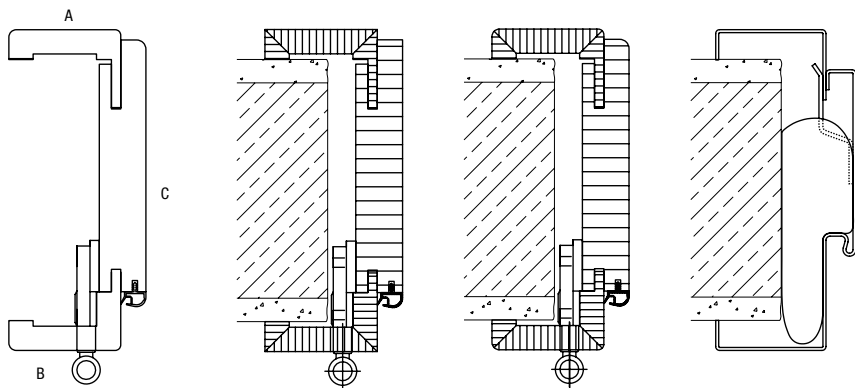

A: Decorative edge  
B: Rebate cladding  
C: Jamb lining

Timber frame, angular

Timber frame, round edge

Steel case frame VarioFix

Dimensions in mm

## Horizontal view – single-leaf

### Rebated

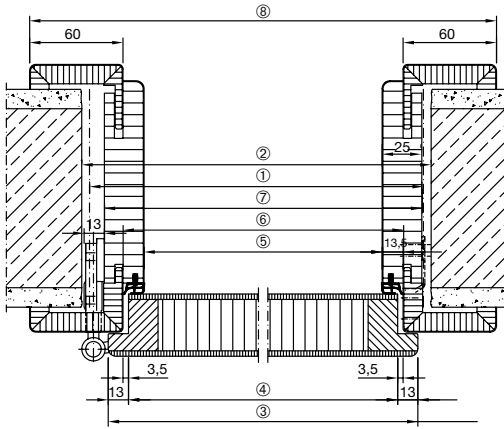

### Flush

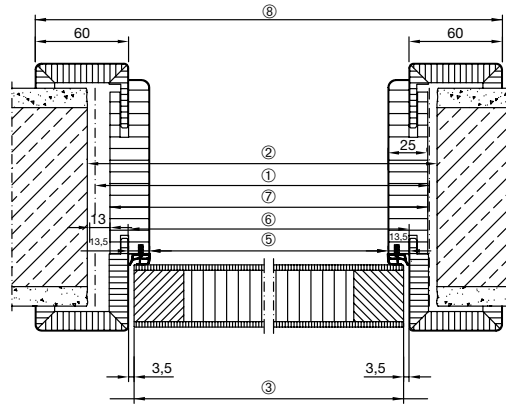

1	Nominal size width		625	750	875	1000	1125	1250
2	Wall opening		635	760	885	1010	1135	1260
3	Overall door leaf dimension	Rebated	610	735	860	985	1110	1235
		Flush	584	709	834	959	1084	1209
4	Leaf rebate dimension		584	709	834	959	1084	1209
5	Clear passage dimension		564	689	814	939	1064	1189
6	Frame hold dimension		591	716	841	966	1091	1216
7	Overall lining dimension		614	739	864	989	1114	1239
8	Overall frame dimension		711	836	961	1086	1211	1336

## Horizontal view – double-leaf

### Rebated

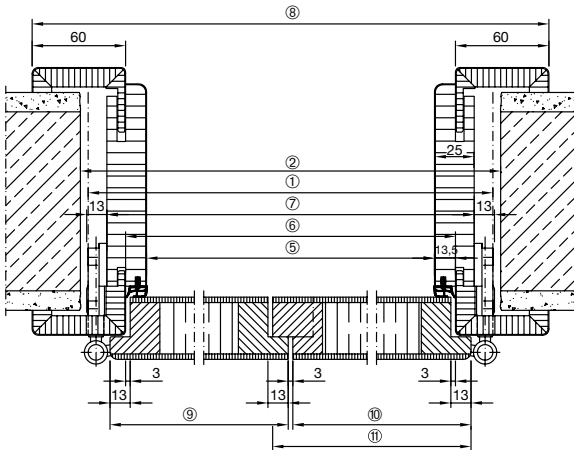

### Flush

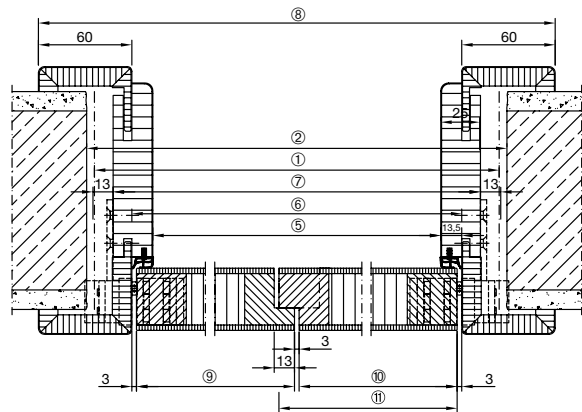

1	Nominal size width		1250	1375	1500	1750	1875	2000	2250	2500
2	Wall opening		1260	1385	1510	1760	1885	2010	2260	2510
5	Clear passage dimension		1176	1301	1426	1676	1801	1926	2176	2426
6	Frame hold dimension		1203	1328	1453	1703	1828	1953	2203	2453
7	Overall lining dimension		1226	1351	1476	1726	1851	1976	2226	2476
8	Overall frame dimension		1323	1448	1573	1823	1948	2073	2323	2573
3	Overall door leaf dimension Traffic leaf	Rebated	610	735	735	860	985	985	1110	1235
		Flush	597	722	722	847	972	972	1097	1222
3	Overall door leaf dimension Fixed leaf with meeting style*	Rebated	610	610	735	860	860	985	1110	1235
		Flush	597	597	722	847	847	972	1097	1222
3	Overall door leaf dimension Fixed leaf with counter rebate	Rebated	623	623	748	873	873	998	1123	1248
		Flush	610	610	735	860	860	985	1110	1235

Dimensions in mm

\* Only for Carolina door styles

# Experience Hörmann quality in new construction and modernisation

Hörmann products have impressive durability and high functionality.  
You can easily plan for new construction as well as modernisation.  
The carefully coordinated solutions make your home more beautiful,  
more secure and more comfortable.

**GARAGE DOORS. GATE AND DOOR OPERATORS. ENTRANCE DOORS. RESIDENTIAL  
INTERNAL DOORS. STEEL DOORS. FRAMES. STORAGE SPACE SYSTEMS.**



Some of the products shown are equipped with special equipment and do not always correspond to the standard versions. The surface finishes and colours shown are subject to the limitations of the printing process and cannot be regarded as binding. All rights reserved. No part may be reproduced without our prior permission. Subject to changes.