

**MultiPoint, height-adjustable hinge, European sizes,
adjustable block frame, ASSA handle system**



MZ Multi-Purpose Door

High-quality steel doors for internal and external applications







Design features	4
MZ multi-purpose door	5
MZ Sentinel Basic multi-purpose doors	6
MZ Sentinel MultiPoint multi-purpose doors	7
Special equipment	8 – 9
Ordering sizes, frame types, fitting methods	10 – 14
Hörmann product range	15

Copyright: No part or excerpt may be reproduced without our permission. Subject to changes. Some of the doors shown are special versions and may require approval in individual cases.

The architects' programme and further information on Hörmann products can be found in the Internet: www.hoermann.com.

Design Features

MZ, MZ Sentinel Basic, MZ Sentinel Multipoint

Stable quality

Multi-purpose doors for internal and external use have been tried and tested for more than four decades because they are so sturdy, durable, and weather-resistant. We offer them single-leaf, double-leaf and with glazing cut-out on request.

Door leaves

Hörmann MZ steel doors are very durable and extremely stable thanks to a double-skinned door leaf additionally reinforced with steel.

Surface

Hörmann exclusively uses galvanized steel which is primed with a high-quality powder coating. This is the prerequisite for a high level of corrosion-protection. Available from 20 units.



Block frame

On request, MZ doors can also be delivered with a block frame for fitting in the opening or on the wall, including 3-sided sealing profile.

Bottom edge

With or without threshold (easily-to-remove threshold profile).

Frame with seal

Corner frame, 2 mm thickness, with allround EPDM seal (included separately) and easy-to-remove threshold profile.



Thermal and acoustic insulation

Thanks to an all-round seal and door leaf infill, ready-to-fit MZ doors offer good sealing and thermal and acoustic insulation characteristics.

Hinges (corner frame)

As standard, the multi-purpose doors are equipped with a spring hinge and a construction hinge according to DIN 182272 (MZ-1) or a height-adjustable construction hinge (MZ-1 with block frame, MZ-2, MZ-Sentinel).

Height-adjustable door leaf

The height-adjustable construction hinge enables fine adjustment of the door leaf afterwards.



Steel Door MZ

Single and double-leaf



Thin rebate

Rebated on 2 sides
Door leaf thickness
45 mm



Door set

Ready-to-fit, with
corner frame,
dual handed

Main function

Multi-purpose door



Additional function



Fire-retarding

MZ-1 with
corner frame and
full door leaf
Up to 1000 x 2125 mm
(H8-5)

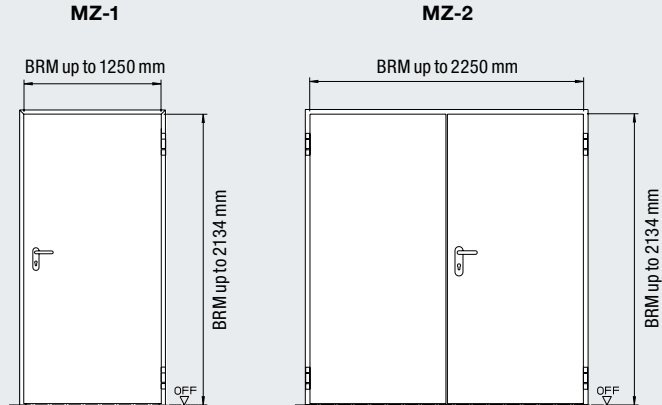

Standard features

Lock and lever handle

Dual-handed mortice lock with lever/knob,
prepared for profile cylinder with deadlock insert
Black plastic lever handle set with steel core,
suitable for profile cylinder and deadlock key

Hinges

One spring hinge
One height-adjustable construction hinge (MZ-2)
Block frame in general with height adjustable KO hinge
(see sentinel)

Security bolts

2 steel bolts (on hinge side)

Fitting in

- Brickwork
- Concrete
- Fitting to other wall types on request

MZ-1 performance characteristics

Thermal insulation

$U_D 1.7 \text{ W/m}^2\text{K}^*$

Acoustic insulation

$RW = \text{approx. } 39 \text{ dB}$

Door bottom edges

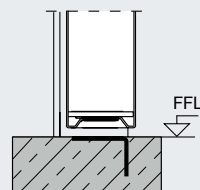

Without threshold

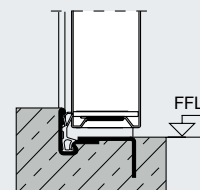

With threshold and seal

Optional extras

Special equipment Page 8 – 9

*for doors without glazing with corner frame and all-round seal

Steel Door MZ Sentinel Basic

Single and double-leaf

*with height-adjustable
construction hinge*



Thin rebate

Rebated on 3 sides
Door leaf thickness
45 mm

Main function

Multi-purpose door

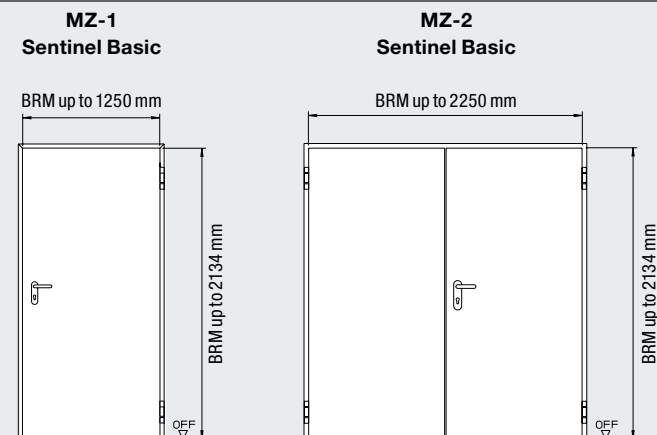

Standard features

Frame	Special four-sided corner frame, 2.0 mm thick, with all-round EPDM sealing profile and welded-on grouting lugs
Surface	Door leaves and corner frame made of galvanized material, primed and powder-coated Grey white (based on RAL 9002)
Lock and lever handle	Mortice lock with lever/knob, prepared for profile cylinder, with deadlock insert Black plastic lever handle set with steel core, suitable for profile cylinder and deadlock key
Hinges	One spring hinge One height-adjustable construction hinge
Security bolts	2 steel bolts (on hinge side)
Fitting in	- Brickwork - Concrete - Fitting to other wall types on request

MZ-1 performance characteristics

Thermal insulation	$U_D 1.7 \text{ W/m}^2\text{K}^*$
Acoustic insulation	$RW = \text{approx. } 39 \text{ dB}^*$

Door bottom edges

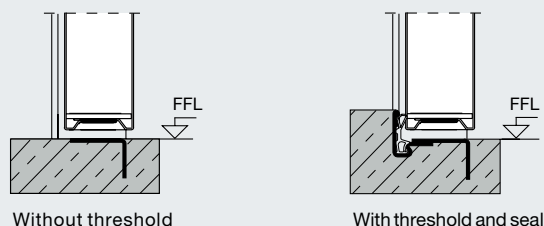

Optional extras

Special equipment Page 8 – 9

*for doors without glazing with corner frame and all-round seal

Steel Door MZ Sentinel MultiPoint

Single-leaf with multiple-point locking

*with height-adjustable
construction hinge*



Thin rebate
Rebated on 3 sides
Door leaf thickness
45 mm



Main function
Multi-purpose door

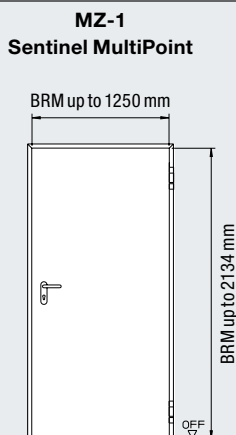

Standard features

Lock and lever handle	Surface-mounted, 3-point locking panic systems. Door leaf without interior lock
Hinges	One spring hinge One height-adjustable construction hinge
Security bolts	2 steel bolts (on hinge side)

Fitting in	- Brickwork - Concrete - Fitting to other wall types on request
-------------------	---

Performance characteristics

Thermal insulation	$U_d 1.7 \text{ W/m}^2\text{K}^*$
Acoustic insulation	$RW = \text{approx. } 39 \text{ dB}^*$

Door bottom edges

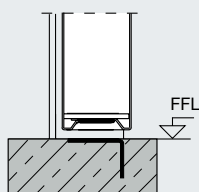

Without threshold

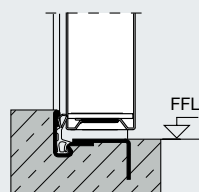

With threshold and seal

Optional extras

Special equipment Page 8–9

* for doors without glazing with corner frame and all-round seal

More design flexibility through varied equipment.

Make the most of daylight for added illumination

On request, we provide the MZ doors also with glazing on the glazing frame: aluminium natural finish. Glazing beads: on opposite hinge side, on request on hinge side.

Glazing: 7-mm wired glass as standard, on request with 20-mm insulated wired glass.



MZ glazing cut-out (MZ door/MZ-Sentinel)
View: 230 x 1360 mm



Round glazing (MZ-Sentinel) Ø 300 mm



Glazing cut-out Figure 5 (MZ-Sentinel)



Ventilation grille

Fitted in the bottom section, doors with ventilation are not suitable for right handing/left handing.



Plastic ventilation grille
455 x 90 mm



Aluminium ventilation grille
425 x 75 mm

Wide-angle spyhole

Spyhole preparation Ø 15 mm. Fitting also available on-site.



Rain canopy

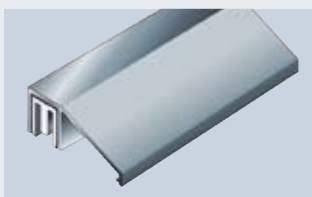

Paintable aluminium, attachable

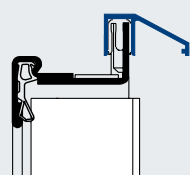

Door drip

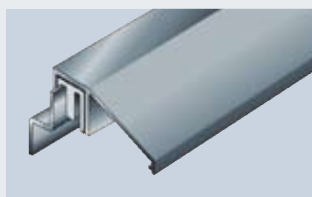

Only for single-leaf MZ doors, screw-on

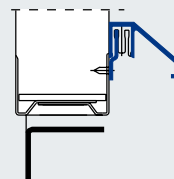



Hörmann quality means all optional extras are designed for a perfect fit and attractive look for safe and long-life performance.

Lever handle sets

The handles as lever, lever/knob or anti-panic handle sets are available with short escutcheon or rose escutcheon in plastic, aluminium or stainless steel. Of course, they can also be equipped with all other conventional sets.



Lever handle set, PC/DL



Lever/knob handle set, PC

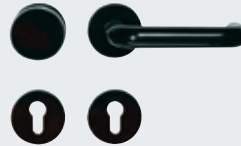

Lever/knob handle set, PZ rose escutcheon



ASSA lock 565, only for MZ Sentinel Basic doors with block frame and adjustable side frames

Closing devices

Multi-purpose doors are generally self-locking. In single leaf doors, this occurs as standard with a spring hinge. Depending on the size, equipment, use or fitting, we also offer you ex-factory single-leaf doors with the exclusive slide rail door closer HDC 35.



Exclusive slide rail door closer HDC 35 //NEW
For single-leaf doors (on request also for double-leaf doors).

Locks

Hörmann's dual-handed anti-panic lock prepared for profile cylinder with lever/knob or with split spindle and lever handle can, of course, be used with profile cylinders (PC) and deadlocks (DL) through the use of a clip.

A deadlock key is included. Also available for round cylinders. Profile cylinder on request: 31.5 + 31.5 mm with 3 keys.

MZ Sentinel Basic



Anti-panic push bar



Anti-panic handle bar

MZ Sentinel MultiPoint



3-point, surface-mounted anti-panic handle bar (Type A)



3-point, surface-mounted anti-panic handle bar (Type B)

Special equipment



Steel threshold profile



Aluminium threshold with seal

Frame types, fitting methods, ordering sizes

Corner frame

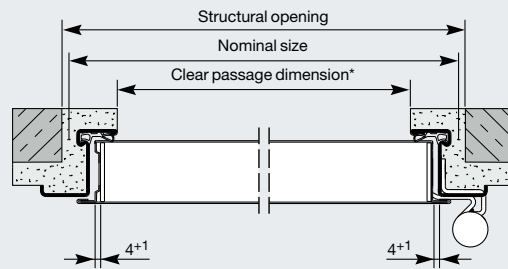
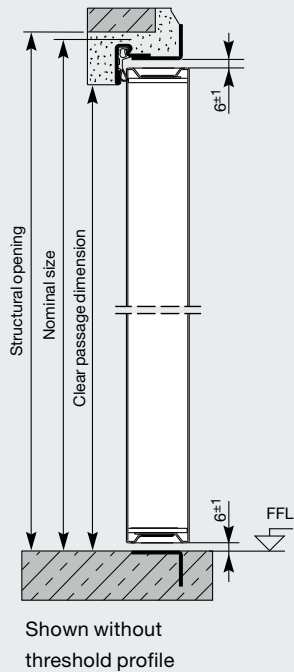

* With an opening angle of 90° and without handles and levers, the clear passage width is reduced by + / -25 mm.

European Sizes

According to nominal size

Nominal size Ordering size width × height	Clear passage width × height	Structural opening width × height
Single-leaf		
750 × 2000	682 × 1966	760 × 2005
875 × 1875	807 × 1841	885 × 1880
875 × 2000	807 × 1966	885 × 2005
875 × 2125	807 × 2091	885 × 2130
1000 × 2000	932 × 1966	1010 × 2005
1000 × 2125	932 × 2091	1010 × 2130
1125 × 2125	1057 × 2091	1135 × 2130
1250 × 2000	1182 × 1966	1260 × 2005
1250 × 2125	1182 × 2091	1260 × 2130
Double-leaf		
1500 × 2000	1432 × 1966	1510 × 2005
1750 × 2000	1682 × 1966	1760 × 2005
2000 × 2000	1932 × 1966	2010 × 2005
2000 × 2125	1932 × 2091	2010 × 2130

According to structural opening

Structural opening Ordering size width × height	Clear passage width × height
Single-leaf	
800 × 2000	722 × 1961
800 × 2100	722 × 2061
900 × 2000	822 × 1961
900 × 2100	822 × 2061
1000 × 2000	922 × 1961
1000 × 2100	922 × 2061
1200 × 2000	1122 × 1961
1200 × 2100	1122 × 2061
Double-leaf	
1600 × 2000	1522 × 1961
1800 × 2000	1722 × 1961
2000 × 2000	1922 × 1961
2000 × 2100	1922 × 2061

Anchor spacings

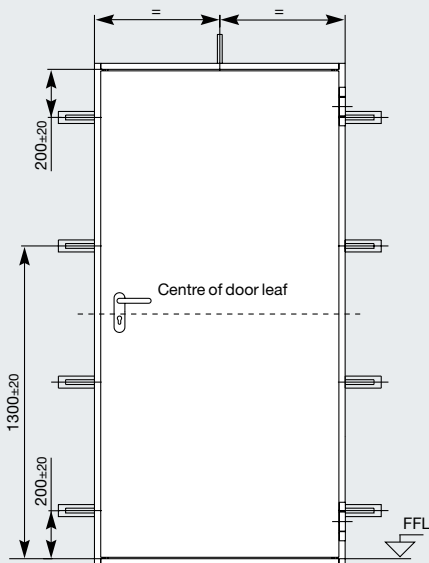

Frame types

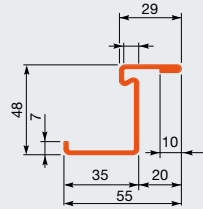

Standard corner frame,
on request with counter frame

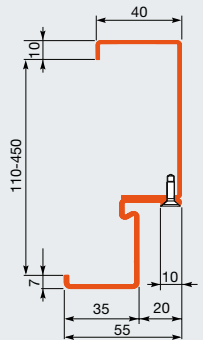

Standard special corner frame,
on request with counter frame

Fitting methods

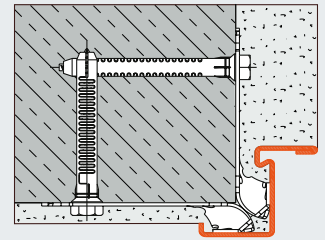

Fitting with grouting lugs

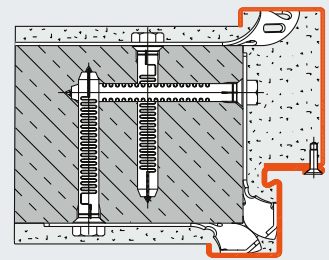

Fitting with grouting lugs

Corner frames

Counter frame, 3-sided, screw-on, 1.5 mm thick, galvanized,
wall widths 110 - 450 mm available on request

According to clear passage

Clear passage Ordering size width × height	Structural opening width × height
Single-leaf	
800 × 1850	878 × 1889
800 × 2000	878 × 2039
800 × 2025	878 × 2064
800 × 2100	878 × 2139
850 × 1850	928 × 1889
850 × 2000	928 × 2039
850 × 2025	928 × 2064
850 × 2100	928 × 2139
1000 × 1850	1078 × 1889
1000 × 2000	1078 × 2039
1000 × 2025	1078 × 2064
1000 × 2100	1078 × 2139
Double-leaf	
1600 × 2000	1678 × 2039
1800 × 2000	1878 × 2039
2000 × 2000	2078 × 2039
2000 × 2100	2078 × 2139

Frame types, fitting methods, ordering sizes

Block frame type N and type S

Block frame for fitting in the opening

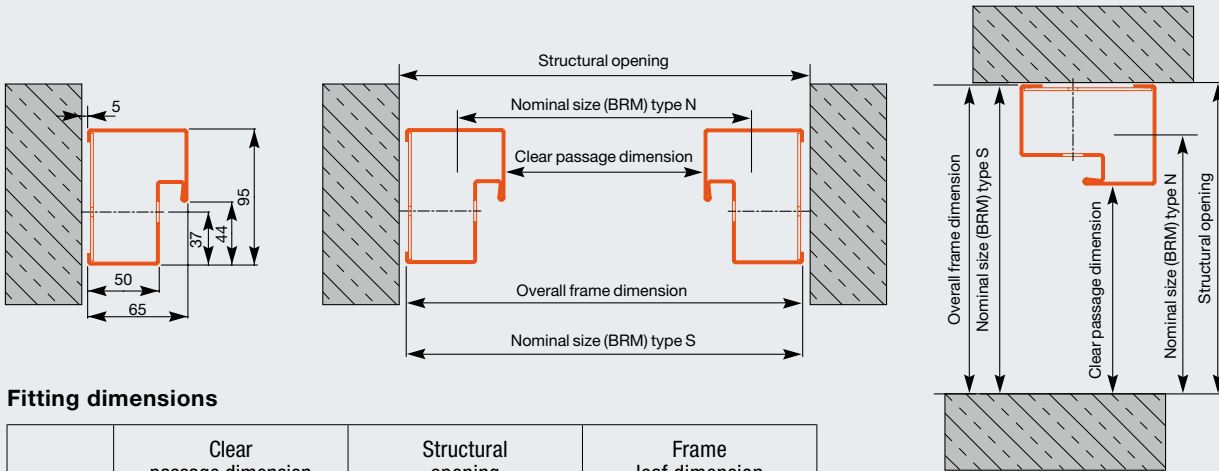

Fitting dimensions

	Clear passage dimension (LD)	Structural opening (LM)	Frame leaf dimension (RAM)
Type N			
Width	BRM width -68	BRM width +82	BRM width +72
Height	BRM height -34	BRM height +41	BRM height +36
Type S			
Width	BRM width -130	BRM width +10	BRM width
Height	BRM height -65	BRM height +5	BRM height

European Sizes

According to nominal size

BRM type N Ordering size width × height	Clear passage dimension width × height	Structural opening (fitting in the opening) width × height	Structural opening (Fitting in front of the opening) width × height
Single-leaf			
750 × 2000	692 × 1969	832 × 2039	692 × 1971
875 × 1875	817 × 1844	957 × 1914	817 × 1846
875 × 2000	817 × 1969	957 × 2039	817 × 1971
875 × 2125	817 × 2094	957 × 2164	817 × 2096
1000 × 2000	942 × 1969	1082 × 2039	942 × 1971
1000 × 2125	942 × 2094	1082 × 2164	942 × 2096
1125 × 2125	1067 × 2094	1207 × 2164	1067 × 2096
1250 × 2000	1192 × 1969	1332 × 2039	1192 × 1971
1250 × 2125	1192 × 2094	1332 × 2164	1192 × 2096
Double-leaf			
1500 × 2000	1442 × 1969	1582 × 2039	1442 × 1971
1750 × 2000	1692 × 1969	1832 × 2039	1692 × 1971
2000 × 2000	1942 × 1969	2082 × 2039	1942 × 1971
2000 × 2125	1942 × 2094	2082 × 2164	1942 × 2096

According to structural opening

Structural opening Ordering size width × height	Clear passage dimension (fitting in the opening) width × height	Clear passage dimension (Fitting in front of the opening) width × height
Single-leaf		
800 × 2000	660 × 1930	790 × 1995
800 × 2100	660 × 2030	790 × 2095
900 × 2000	760 × 1930	890 × 1995
900 × 2100	760 × 2030	890 × 2095
1000 × 2000	860 × 1930	990 × 1995
1000 × 2100	860 × 2030	990 × 2095
1200 × 2000	1060 × 1930	1190 × 1995
1200 × 2100	1060 × 2030	1190 × 2095
Double-leaf		
1600 × 2000	1460 × 1930	1590 × 1995
1800 × 2000	1660 × 1930	1790 × 1995
2000 × 2000	1860 × 1930	1990 × 1995
2000 × 2100	1860 × 2030	1990 × 2095

Block frame for fitting on the wall

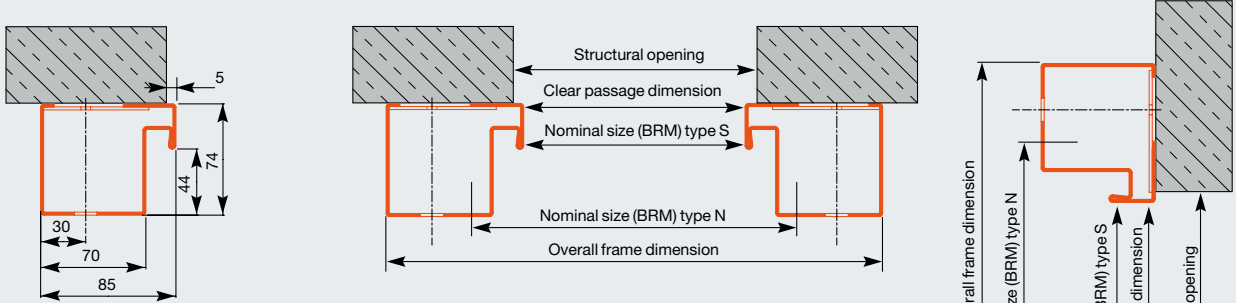

Fitting dimensions

	Clear passage dimension (LD)	Clear opening (LM)	Frame leaf dimension (RAM)
Type N			
Width	BRM width -58	BRM width -58	BRM width +102
Height	BRM height -29	BRM height -29	BRM height +51
Type S			
Width	BRM width	BRM width	BRM width +170
Height	BRM height	BRM height	BRM height +85

According to clear passage

Clear passage dimension Ordering size width × height	Structural opening (Fitting in front of the opening) width × height	Structural opening (fitting in the opening) width × height
Single-leaf		
800 × 1850	810 × 1855	950 × 1923
800 × 2000	810 × 2005	950 × 2073
800 × 2025	810 × 2030	950 × 2098
800 × 2100	810 × 2105	950 × 2173
850 × 1850	860 × 1855	1000 × 1923
850 × 2000	860 × 2005	1000 × 2073
850 × 2025	860 × 2030	1000 × 2098
850 × 2100	860 × 2105	1000 × 2173
1000 × 1850	1010 × 1855	1150 × 1923
1000 × 2000	1010 × 2005	1150 × 2073
1000 × 2025	1010 × 2030	1150 × 2098
1000 × 2100	1010 × 2105	1150 × 2173
Double-leaf		
1600 × 2000	1610 × 2005	1750 × 2073
1800 × 2000	1810 × 2005	1950 × 2073
2000 × 2000	2010 × 2005	2150 × 2073
2000 × 2100	2010 × 2105	2150 × 2173

Frame Type

Adjustable frame with plug-and-screw fitting

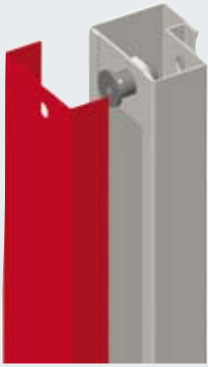

Adjustable frame, type A

Fitting distance 0-25 mm, (12.5 mm per side)

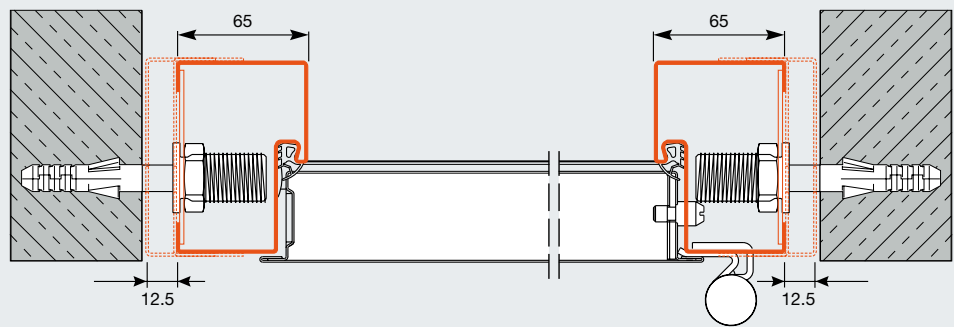
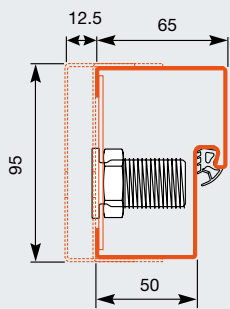

Adjustable frame, type B

Fitting distance 25-50 mm, (12.5 mm per side)

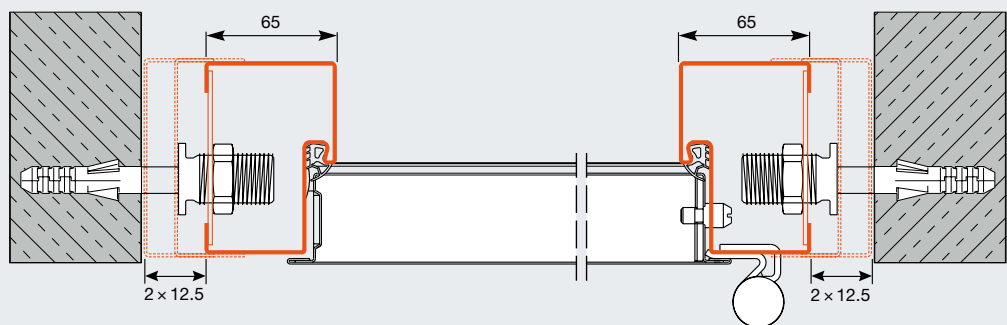
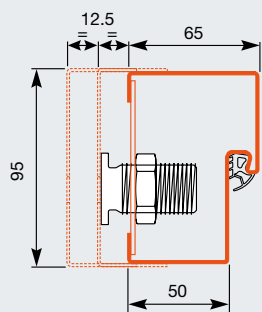

Everything from a single source: For your building projects.



1
Sectional doors



2
Rolling shutters
and rolling grilles



3
Steel and aluminium
folding doors



4
High-speed doors

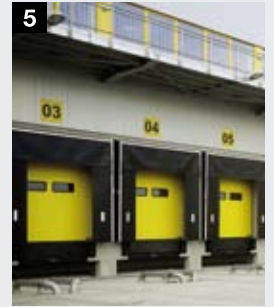

5
Loading technology



6
Fire sliding doors

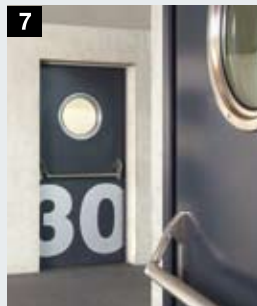

7
Multi-function doors
and reinforced
internal doors



8
Fire and smoke-protection
box frame parts

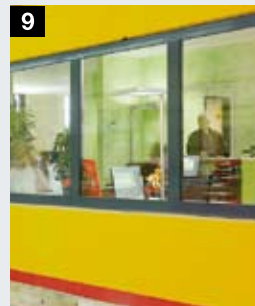

9
Visibility windows



10
Service

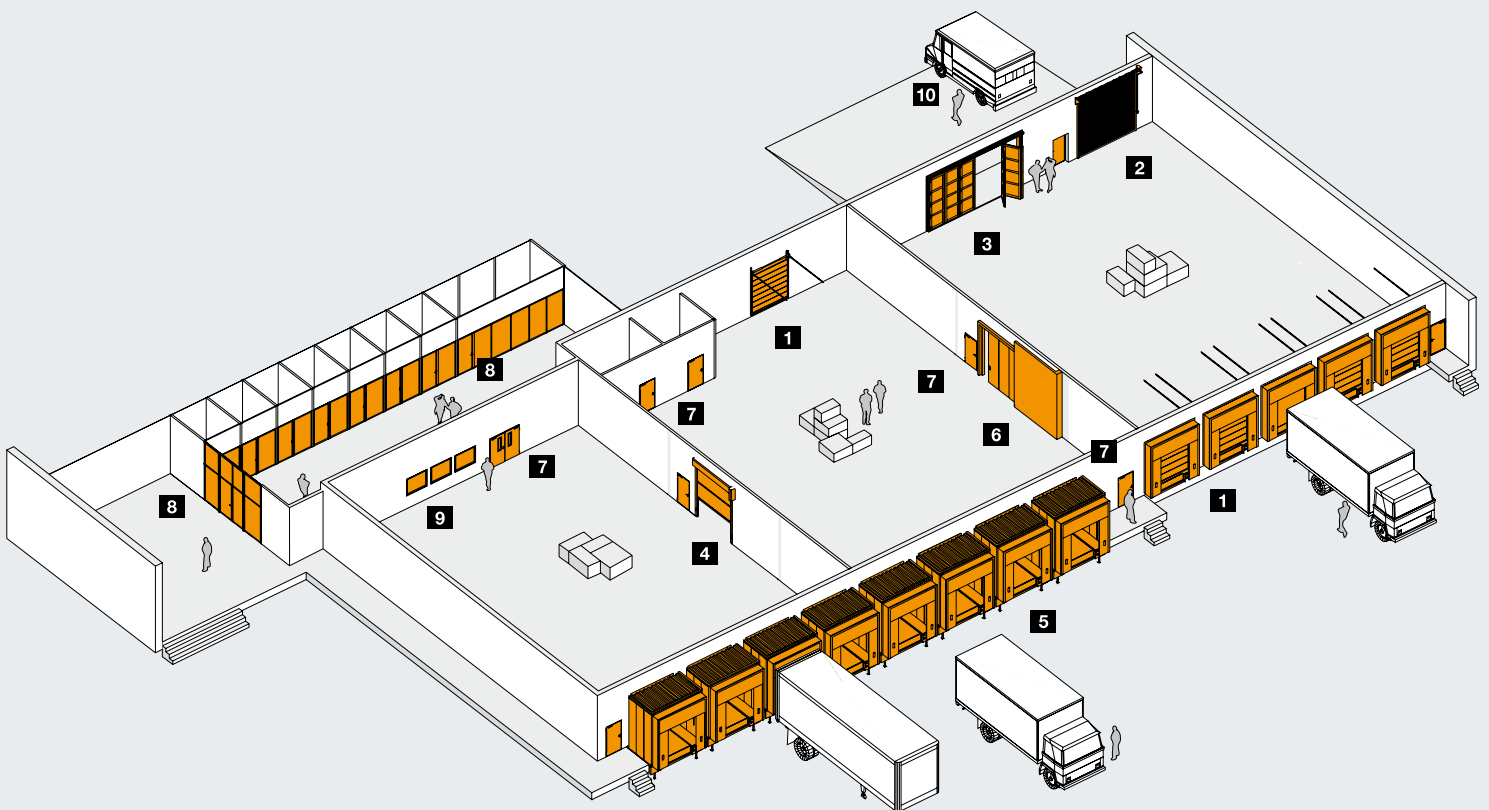

Hörmann: Quality without Compromise



Hörmann KG Amshausen, Germany



Hörmann KG Antriebstechnik, Germany



Hörmann KG Brandis, Germany



Hörmann KG Brockhagen, Germany



Hörmann KG Dissen, Germany



Hörmann KG Eckelhausen, Germany



Hörmann KG Freisen, Germany



Hörmann KG Ichtershausen, Germany



Hörmann KG Werne, Germany



Hörmann Genk NV, Belgium



Hörmann Alkmaar B.V., Netherlands



Hörmann Legnica Sp. z o.o., Poland



Hörmann Beijing, China



Hörmann Tianjin, China



Hörmann LLC, Montgomery IL, USA



Hörmann Flexon, Leetsdale PA, USA

Hörmann is the only manufacturer worldwide that offers you a complete range of all major building products from one source. We manufacture in highly-specialised factories using the latest production technologies. The close-meshed network of sales and service companies throughout Europe, and activities in the USA and China, make Hörmann your strong partner for first-class building products, offering “Quality without Compromise”.

GARAGE DOORS

OPERATORS

INDUSTRIAL DOORS

LOADING EQUIPMENT

HINGED DOORS

DOOR FRAMES

Hörmann (UK) Ltd, Gee Road, Coalville, Leicestershire LE67 4JW
Phone (01530) 513000, Fax (01530) 513001

