



# HIGH-SPEED DOORS

**NEW.** HS 5040 TurboLux – fastest door opening with over 4.0 m/s and maximum transparency

**HÖRMANN**





4

Good reasons  
to try Hörmann  
high-speed doors.



20

Application areas.



34

Versions.  
Accessories.  
Technology.

# Brand quality made in Germany



The family-owned company Hörmann offers all important construction components for building and renovating projects from a single source. We manufacture in highly specialised factories using state-of-the-art production technologies. Our employees work intensively on new products, continual further developments and improvements to details. The results are patents and unique products on the market.





**AN EYE ON THE FUTURE.** Hörmann is setting a good example. That's why 100% of our electricity needs in Germany come from green electricity. Together with an intelligent and certified energy management system, CO<sub>2</sub>-neutral mailing and the recycling of valuable materials, more than 60000 tons of CO<sub>2</sub> are saved each year. In addition, we offset over 100000 tonnes of CO<sub>2</sub> by promoting wind energy and reforestation projects in cooperation with ClimatePartner.



You can find further information at  
[www.hormann.co.uk/company/environment](http://www.hormann.co.uk/company/environment)



# Sustainable planning for trend-setting construction

Experienced specialists within our customer-oriented sales organisation accompany you from the planning stage, through technical clarification up to the final building inspection. Complete working documentation, such as technical manuals, is also always accessible and up-to-date at [www.hoermann.com](http://www.hoermann.com)





**SUSTAINABILITY DOCUMENTED.** Hörmann has already received confirmation of sustainability through an Environmental Product Declaration (EPD) in accordance with ISO 14025 from the Institut für Fenstertechnik (ift – Institute of window technology) in Rosenheim, Germany. This EPD was created based on EN ISO 14025:2011 and EN 15804:2012. In addition, the general guidelines for the preparation of type III Environmental Product Declaration apply. The declaration is based on the PCR document “Doors” PCR-TT-1.1:2011.



**ARCHITECTS' PROGRAM.** Clearly structured navigation via drop-down menus and symbols, as well as a search function, provide faster access to texts for invitations to tenders and more than 9000 drawings (in DWG and PDF format) of over 850 Hörmann products. In addition, BIM data can be provided for many products for the Building Information Modelling process, enabling efficient planning, drafting, construction and management of buildings. Photos and photo-realistic presentations provide additional information on many products.



Plan with the Architects' Program at [www.hormann.co.uk/architects-service/architects-programme](http://www.hormann.co.uk/architects-service/architects-programme)



**PRODUCTS  
FOR BIM**

We are a member of the professional association for digital building products in the Federal Association of Building Systems e.V.

# Easy to fit and service

On doors with light grilles integrated in the side elements, no surface-mounted installations (e.g. closing edge safety device or photocell) are required on the door. In addition, the doors can also be integrated into digital service and remote maintenance concepts. This makes Hörmann high-speed doors both economical and sustainable.







**Round-the-clock  
service**

**FAST SERVICE.** Our teams of highly qualified specialists travel all around Germany. But Hörmann also offers consulting, maintenance and repairs in many other countries. Our network of over 500 service technicians guarantees speed and flexibility. We are available around the clock. Our customers can rely on us.



**10-year guaranteed  
availability**

**HÖRMANN SPARE PARTS.** It goes without saying that spare parts for doors, operators, and controls are original Hörmann parts that come with a guaranteed availability of 10 years.



**SmartControl**

**SMART DOOR CONFIGURATION.** Important door information, such as error messages or door cycles, can be accessed via the SmartControl online portal. This reduces costs for service visits and prevents downtime through preventive replacement of wear parts. For robust logistics processes with regard to your door system.

→ For further information, see from page 64.



# Optimised logistics processes

The high opening and closing speeds of Hörmann high-speed doors significantly speed up work processes and considerably reduce thermal losses and draughts. The standard frequency converter control for spiral doors, high-speed sectional doors and flexible high-speed doors\* takes stress off the entire mechanical door elements, guaranteeing nearly wear-free, quiet door travel. Hörmann high-speed doors therefore impress with their long service life and a high level of efficiency.





**NON-CONTACT SAFETY.** On spiral doors, high-speed sectional doors and flexible high-speed doors, the safety light curtain with emergency stop / soft stop function integrated in the side elements **1** monitors the closing zone of the door leaf up to a height of 2500 mm and ensures compliance with the safety requirements according to DIN EN 13241-1. The minimal spacing of the light beams of only 45 mm and the separate diagnosis of the individual light beams with automatic end-of-travel position correction ensure reliable function and increased safety. Furthermore, the gentle emergency-stop / soft stop function slowly stops the door in the event an obstacle is detected with a sufficient remaining travel distance.

On the F 6010 / F 6010 Iso high-speed folding doors, a safety light curtain integrated in the side elements **2** also monitors the closing zone of the curtain up to a height of 2500 mm. The door types F 8005, F 14005 and F 4010 Cold are fitted with a photocell **3** for monitoring the closing zone. These safety devices also meet the requirements according to DIN EN 13241-1.

\* Not with V 3010, V 4008 SEL and V3009 Conveyor (with relay control)

# **NEW.** The fastest turbo spiral door in the world!

The new generation of external and internal doors opens at a record speed of over 4.0 m/s. The very high, impact-resistant polycarbonate sections with a transparency of 90% of the door leaf surface are very durable and easily withstand the demands of a harsh industrial environment.





Only from Hörmann



Opening speed  
over 4.0 m/s

Only from Hörmann



Approx. 90% transparent  
door leaf surface



Service-friendly

**DOOR OPENING AT RECORD SPEED.** The HS 5040 TurboLux S door version opens faster than 4.0 m/s. This minimises the waiting times of transport vehicles in front of the door, so that forklift trucks, for example, can drive through the door without stopping.

**MAXIMUM TRANSPARENCY.** The particularly high door sections with a height of 550 mm offer generous visibility without vertical rails with a transparency of 90% of the door leaf surface. This makes for a bright and friendly working environment and safe transport routes.

**LESS MAINTENANCE WORK REQUIRED.** The HS 5040 TurboLux door version with counterbalance implemented by counter weights convinces with its low wear, since there is no need for replacing any springs every 100000 cycles. This makes the HS 5040 TurboLux virtually wear-free and greatly reduces maintenance costs.

→ For further information, see from page 36.



Watch the video on YouTube or at  
[www.hormann.co.uk/media-centre](http://www.hormann.co.uk/media-centre)

# Spiral doors and high-speed sectional doors

Depending on the version, the galvanized, double-skinned sections are guided in a spiral or in tracks at a speed of up to 2.5 m/s. The sturdy steel sections of the doors have thermal breaks and are PU-foamed. As a result you benefit from excellent thermal values of up to  $1.04 \text{ W}/(\text{m}^2 \cdot \text{K})$  and minimise energy loss.





### RC2 security features

Tested and certified

**RC2 SECURITY AS STANDARD.** Industrial doors with RC2 security equipment withstand an attack using tools such as screwdrivers, pliers and wedges for a total of three minutes. Usually this is too long for burglars, so they generally stop their criminal act. The HS 7030 PU 42 spiral door is tested and certified as standard in resistance class RC2 in accordance with the new DIN / TS 18194 standard and impresses as a secure hall closure at night.



### Duratec

Extremely scratch-resistant

**OPTIONAL GLAZING.** Duratec glazing guarantees maximum scratch resistance despite heavy use in rough industrial environments. This special surface coating protects the pane from scratches and damage caused by cleaning.



### Service-friendly

Thanks to counterbalance via counter weights

**LESS MAINTENANCE WORK REQUIRED.** The HS 7030 PU 42 door version is equipped with weight compensation via counter weights up to a door size of 5000 mm width and / or 5000 mm height and convinces with low wear and greatly reduced maintenance costs.

→ For further information, see from page 38.



Watch the video on YouTube or at [www.hormann.co.uk/media-centre](http://www.hormann.co.uk/media-centre)

# High-speed doors with flexible door leaf

High-speed doors with flexible door leaf feature safe door operation and a long service life thanks to standard equipment with a frequency converter control, safety light curtain and SoftEdge bottom profile. In addition, they are low-maintenance, easy to fit, cost-efficient and therefore economical for daily use.







No downtimes resulting from a crash thanks to the innovative SoftEdge bottom profile



Reliable radio crash switch concealed in the SoftEdge bottom profile

**NO DOWNTIMES RESULTING FROM A CRASH.** The innovative SoftEdge bottom profile prevents damage and resulting downtimes of the door system. Extensive repairs, such as those with rigid bottom profiles, usually do not become necessary. SoftEdge ensures trouble-free operation and production processes.

**RADIO CRASH SWITCH.** The radio crash switch is concealed in the SoftEdge bottom profile. If the profile is pushed out of the side guides by a crash, the radio crash switch transmits a signal to the control and the door is stopped immediately, fulfilling the requirements of DIN EN 13241-1.

→ For further information, see from page 46.



Watch the video on YouTube or at [www.hormann.co.uk/media-centre](http://www.hormann.co.uk/media-centre)

# Flexible high-speed folding doors

The door construction can either be fitted on the outside or inside of the opening. The curtain is opened using a patented belt system with safety belts and folds in the lintel area. The galvanised steel wind reinforcement laths are arranged across the entire door height and withstand wind loads up to class 4 (optional).



**NO DOWNTIMES RESULTING FROM A CRASH.** The robust frame with innovative flexible guide belts\* prevents damage and resulting downtimes of the door system. In the event of a crash, the floor rail of the curtain is forced out of the guide belts. The curtain can then be reinserted and the door can be operated again. Another advantage of the flexible guide belts is minimal noise during movement of the curtain and the wind reinforcement laths caused by the wind.

\* For F 4010 Cold, F 6010, F 6010 Iso

**STANDARD ANTI-FALL SAFEGUARD.** The high-speed folding doors are opened and closed via two pull belts. In addition, two further safety belts secure the door curtain in the event of damage, e.g. tearing of the pull belts. This patented belt system effectively prevents the door from crashing.

→ For further information, see from page 58.

No downtime after a crash thanks to the innovative flexible guide belts



Standard anti-fall safeguard thanks to two additional safety belts

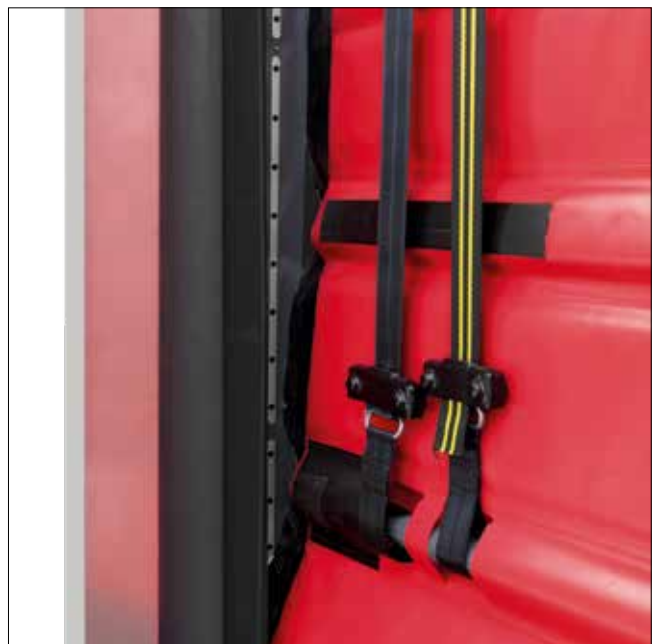

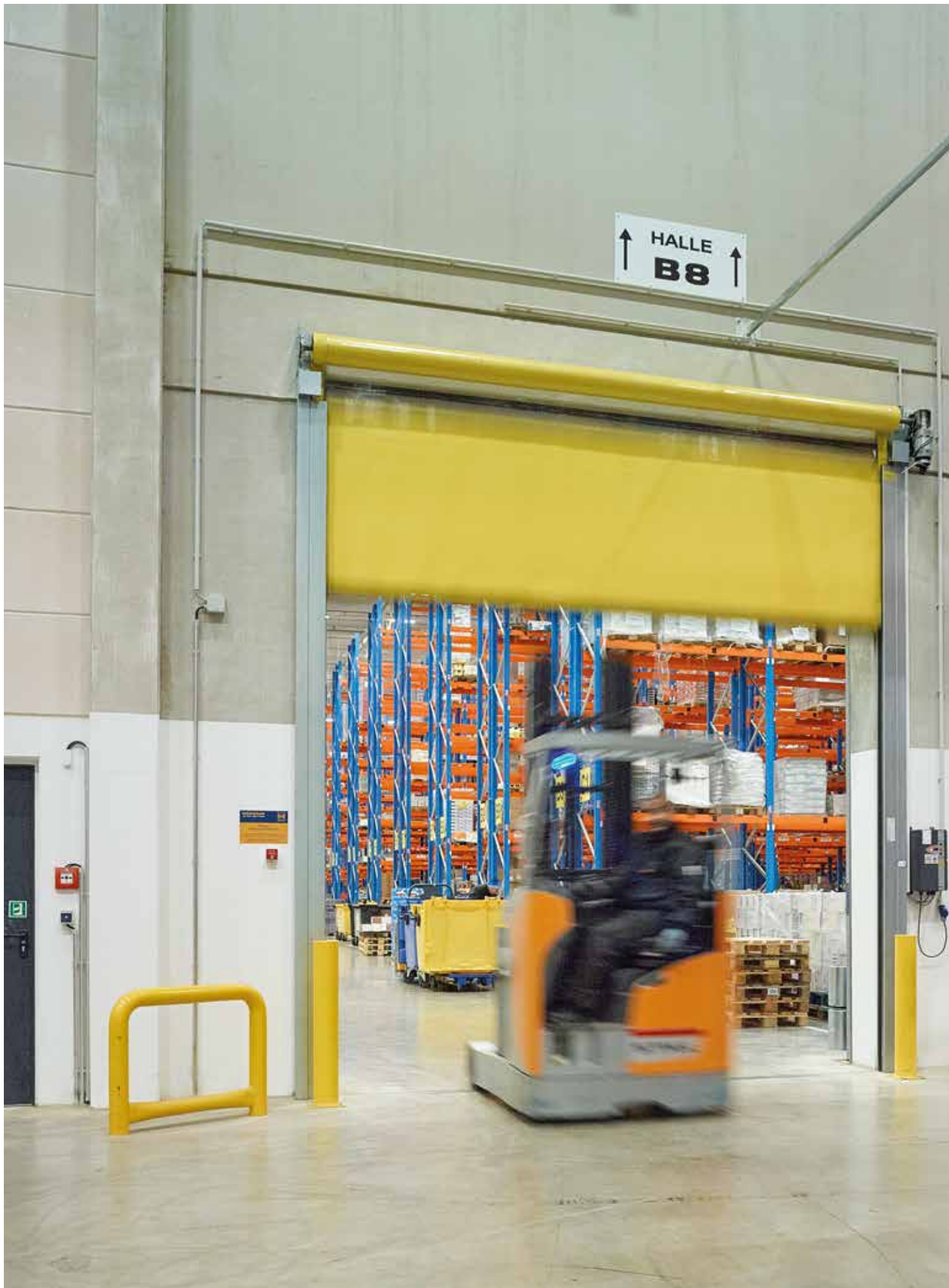



22

Insulated external doors



24

Robust external doors



26

Flexible internal doors



28

Internal doors for cold store  
and deep freeze applications



30

Internal doors for retail  
and food industry



32

Internal doors  
for individual needs



**INSULATED EXTERNAL DOORS.** The spiral and high-speed sectional doors consisting of steel sections with thermal breaks reduce energy losses thanks to their fast opening speeds and convince as secure and very well insulated night doors. Depending on the version, the sections are guided in a spiral or in tracks.

→ For further information, see from page 38.



LEFT. Spiral door HS 5012 PU S

TOP RIGHT. High-speed sectional door HS 5015 PU 42 N  
with track application N

BOTTOM RIGHT. High-speed sectional door HS 5015 PU 42 V  
with track application V



**ROBUST EXTERNAL DOORS.** The flexible high-speed doors and high-speed folding doors easily withstand wind loads and reduce energy losses as well as draughts. The V 10008 high-speed door and the F 8005 and F 14005 high-speed folding doors are specifically developed for large openings and high wind loads of up to 100 km/h.

→ For further information on the turbo spiral door, see from page 36.

→ For further information on high-speed doors, see from page 52.

→ For further information on high-speed folding doors, see from page 58.







TOP LEFT. High-speed folding door F 14005 with an operator on both sides

TOP CENTRE LEFT. High-speed door V 6030 SEL

TOP RIGHT. High-speed door V 10008

BOTTOM. Turbo spiral door HS 5040 TurboLux .NEW



**FLEXIBLE INTERNAL DOORS.** Thanks to the high opening and closing speeds, heat losses as well as draughts at the workplace are noticeably reduced, resulting in less work absences due to illness. Vision fields or fully transparent curtains make for a bright and friendly working environment and provide visibility for safe transport routes.

→ For further information on the turbo spiral door, see from page 36.

→ For further information on high-speed doors, see from page 46.

→ For further information on high-speed folding doors, see from page 58.

TOP. Turbo spiral door HS 5040 TurboLux .NEW

BOTTOM LEFT. High-speed folding door F 8005

BOTTOM CENTRE. High-speed door V 5015 SEL

BOTTOM RIGHT. High-speed door V 6020 TLR







TOP. High-speed sectional door IsoSpeed Cold 100  
BOTTOM LEFT. High-speed folding door F 4010 Cold  
BOTTOM RIGHT. High-speed door V 4015 Iso L





**INTERNAL DOORS FOR COLD STORE AND DEEP FREEZE APPLICATIONS.** The IsoSpeed Cold 100 high-speed sectional door, the V 4015 Iso L high-speed door and the F 4010 Cold high-speed folding door are the ideal solutions for various applications in cold and refrigeration logistics. Their sections with thermal breaks and insulated curtains reliably reduce cold losses in cold store areas. Opening speeds up to 2 m/s ensure rapid traffic flow to maintain the cold chain.

→ For further information on the turbo spiral door, see from page 42.

→ For further information on high-speed doors, see from page 54.

→ For further information on high-speed folding doors, see from page 58.





TOP LEFT. High-speed door V 2515 Food L  
TOP RIGHT. Easy cleaning of the high-speed door L 2515 Food L  
BOTTOM LEFT. High-speed door V 2012 with custom imprint  
BOTTOM RIGHT. High-speed door V 3010





### **INTERNAL DOORS FOR RETAIL AND FOOD INDUSTRY.**

The space saving V 2012 and V 3010 doors are specially designed as safe internal doors in commercial enterprises with high customer frequency. Specifically designed for use in the food industry, the door types V 2515 Food L and V 3010 are made entirely of stainless steel. They can be cleaned very easily using high-pressure cleaners.

→ For further information, see from page 48.

**INTERNAL DOORS FOR INDIVIDUAL NEEDS.** Various demands require individual door solutions. Based on our expert know-how, we develop customer-specific solutions for special application areas such as conveyor systems, clean rooms or for machine safety.

→ For further information, see from page 56.







TOP. High-speed door V 3009 Conveyor

BOTTOM LEFT. High-speed door V 5030 MSL

BOTTOM RIGHT. High-speed door V 3015 Clean



38



46



58

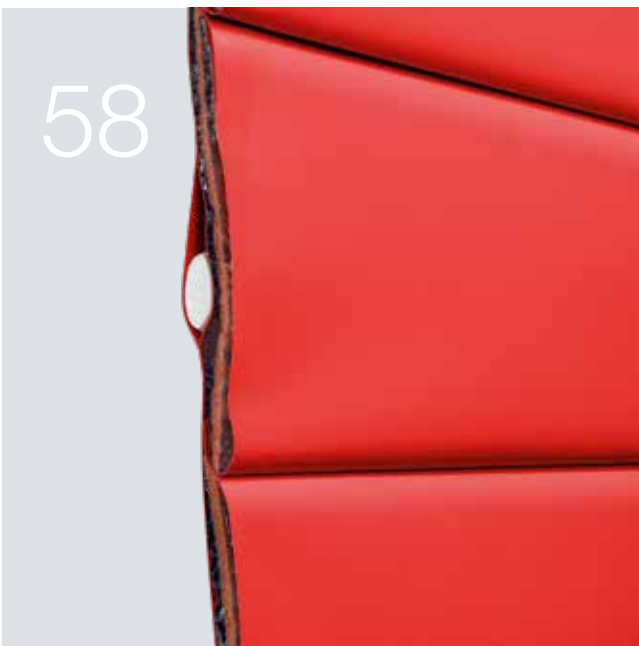

# Versions. Accessories. Technology.

- 36 Turbo spiral doors
- 38 Spiral doors and high-speed sectional doors
- 46 High-speed doors with flexible door leaf
- 58 High-speed folding doors
- 62 Individual colour schemes
- 64 Controls
- 68 Accessories

# Turbo spiral doors

HS 5040 TurboLux .NEW

| Door type   | HS 5040 TurboLux S   | HS 5040 TurboLux   |
|---|--|--|
| <b>Door leaf</b>                                      |  |  |
| Construction  | Impact-resistant polycarbonate sections, divided by aluminium profiles | Impact-resistant polycarbonate sections, divided by aluminium profiles |
| Depth (mm)  | 1,5  | 1,5  |
| Section height (mm)                                   | 550  | 550  |
| <b>Suitable application</b>                           | Interior / exterior  | Interior / exterior  |
| <b>Size range</b>                                     |  |  |
| Max. width (mm)                                       | 5000   | 5000   |
| Max. height (mm)                                      | 5000   | 5000   |
| Min. required headroom (mm)                           | 1200   | 1200   |
| <b>Control</b>  |  |  |
| Standard  | BK 150 FUE-1   | AK 150 FUE-1   |
| <b>Safety</b>   |  |  |
| Light grille with emergency stop / soft stop function | ●  | ●  |
| <b>Speed</b>  |  |  |
| Max. opening (m/s)                                    | >4.0   | 3,5  |
| Closing approx. (m/s)                                 | 1,0  | 1,0  |
| <b>Resistance to wind load (EN 12424)</b>             |  |  |
| Class 2   | ●  | ●  |
| Class 4   | ○  | ○  |
| <b>Counterbalance</b>                                 |  |  |
| Counter weight  | -  | ●  |
| Springs   | ●  | -  |
| <b>Emergency opening / closing</b>                    |  |  |
| Emergency hand chain                                  | ●  | ●  |
| Secured release                                       | ●  | -  |

● = Standard ○ = Optional



### Only from Hörmann

90% transparent door leaf

### Only from Hörmann

Opening speed over 4.0 m/s  
for HS 5040 TurboLux S

### Only from Hörmann

Counterbalance via counter weights  
for HS 5040 TurboLux

#### Record speed

The fastest turbo spiral door in the world opens at a record speed of over 4.0 m/s, while featuring a particularly quiet door travel. Fast opening minimises operating costs by reducing waiting times in front of the door and speeding up logistics processes.

#### Maximum transparency

The high-speed door leaf features a transparency of approx. 90%. The impact-resistant polycarbonate sections **1** are very sturdy and easily withstand the demands of a harsh industrial environment.

#### Space-saving construction

Thanks to the particularly powerful operator **2** fitted on the inside and its very narrow side elements **3**, the new high-speed door only requires 255 mm sideroom for fitting.

#### Shaft cover

The transparent shaft cover **4** protects the door leaf from soiling.

#### Easy to service and maintain

Hörmann is the only manufacturer to use counter weights instead of springs for counterbalance on the HS 5040 TurboLux. This makes the door virtually wear-free and greatly reduces maintenance costs since it does away with the need for spring replacement after approx. 100000 door cycles.

#### Non-contact safety

The safety light curtain with emergency stop / soft stop function integrated in the side elements **5** monitors the closing zone of the door leaf up to a height of 2500 mm and ensures compliance with the safety requirements according to DIN EN 13241-1.



# Spiral doors and high-speed sectional doors

## Section versions

### Steel sandwich section with thermal break

The 42 mm thick PU foamed steel sections **1** are particularly robust and offer excellent thermal insulation which can be further improved with an optional ThermoFrame. The sections are delivered with elegant Micrograin surface **3** on the exterior and Stucco surface **4** on the interior – exterior and interior are White aluminium based on RAL 9006 as standard.

### Acoustic sections

For the special requirements of acoustic insulation, the Acoustic high-speed doors are equipped with aluminium hollow profiles **2**. The hollow profiles are filled with 5 mm UPVC and 30 mm PU foam.

### Increased thermal insulation thanks to ThermoFrame

Well-insulated high-speed doors are essential in heated halls. The ThermoFrame **5** separates the side element from the building structure. The thermal break along with additional seals improves thermal insulation by up to 15% and is easy and quick to fit. The ThermoFrame is optionally available for doors with 42 mm thick sections.

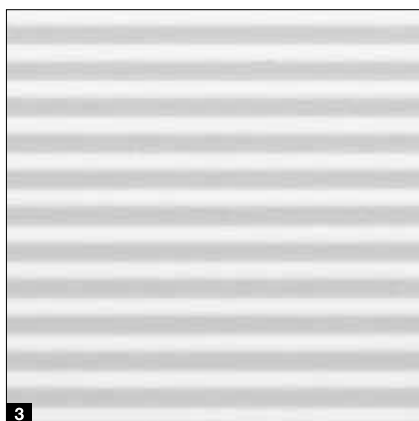

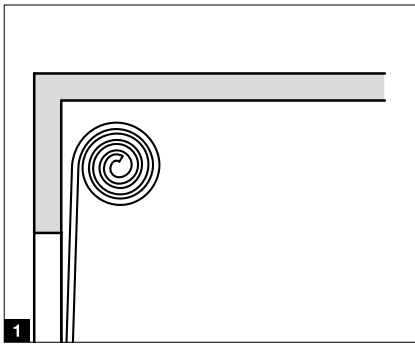

## The compact spiral track application **1**

The sections are securely guided into a spiral bracket without any contact. With the high-performance frequency converter control (FU) the door reaches an opening speed of up to 2.5 m/s. The HS 7030 PU 42 spiral door with chain mechanism and spring compensation can also be fitted externally.

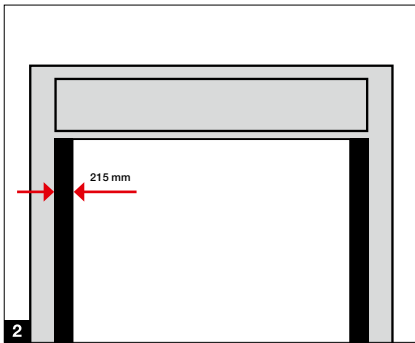

## The spiral track application with narrow side elements **2**

The spiral door with 215 mm instead of 330 mm narrow side elements allows for fitting even in confined spaces. The operator does not require counterbalance. Your double advantage: low purchase price and low service and maintenance costs!

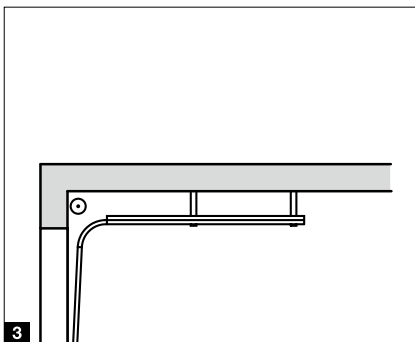

## The space-saving track application **N** **3**

We recommend this track application for tight spaces in the lintel area. A chain mechanism with spring compensation runs the sections into horizontal tracks. This requires a low headroom of only 480 mm.

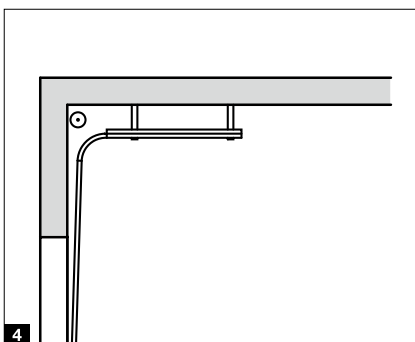

## The adjustable track application **H** **4**

The sections are guided into horizontal tracks and can be diverted depending on the fitting situation. Thus, the door can be fitted behind or above supply lines and crane tracks. Thanks to the belt mechanism with counter weights, the door is especially low-wear and durable.

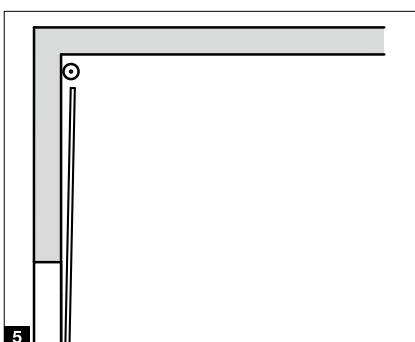

## The wear-free track application **V** **5**

The sections run vertically along the hall wall. That is why the door movements are very quiet and wear-free. The belt mechanism with counter weights guarantees a long service life with constant use.

# Spiral doors and high-speed sectional doors

## Overview

| Door type  | HS 7030 PU 42                          | HS 5012 PU 42 S                        | HS 7030 Acoustic                               |
|--|--|--|--|
| <b>Door hardware</b>   | Spiral track application               | Spiral track application               | Spiral track application                       |
| <b>Door leaf</b>   |  |  |  |
| Construction   | Steel sandwich construction, PU-foamed | Steel sandwich construction, PU-foamed | Aluminium hollow profile, 5 mm UPVC / 30 mm PU |
| Depth (mm)   | 42                                     | 42                                     | 42   |
| Section height (mm)  | 250                                    | 250                                    | 225  |
| Exterior / interior surface  | Micrograin / Stucco                    | Micrograin / Stucco                    | Smooth   |
| Standard colour  | RAL 9006                               | RAL 9006                               | C0 anodised                                    |
| ThermoFrame  | ○                                      | ○                                      | –  |
| Duratec glazing, double  | ○                                      | ○                                      | –  |
| <b>Suitable application</b>  | Interior / exterior                    | Interior / exterior                    | Interior / exterior                            |
| <b>Size range</b>  |  |  |  |
| Max. width (mm)  | 8000                                   | 5000                                   | 5000   |
| Max. height (mm)   | 6500                                   | 5000                                   | 5000   |
| Min. required headroom (mm)  | 920                                    | 920                                    | 1000   |
| <b>Speed</b>   |  |  |  |
| Max. opening (m/s)   | 1.2 – 2.5                              | 1,2                                    | 1.5 – 2.5                                      |
| Closing approx. (m/s)  | 0,5                                    | 0,5                                    | 0,5  |
| <b>Control</b>   |  |  |  |
| Standard   | AK 500 FUE-1                           | AK 500 FUE-1                           | AK 500 FUE-1                                   |
| <b>Safety</b>  |  |  |  |
| Light grille with emergency stop / soft stop function  | ●                                      | ●                                      | ●  |
| <b>Thermal insulation U-value<sup>1)</sup> in W/(m<sup>2</sup>·K)</b><br>(EN 13241-1, ISO 12567-1) | 1,04                                   | 1,04                                   | –  |
| <b>Resistance to wind load</b> (EN 12424)  |  |  |  |
| Door width ≤ 5000 mm   | Class 5                                | Class 5                                | Class 4  |
| Door width > 5000 mm ≤ 6000 mm   | Class 4                                | Class 4                                | –  |
| Door width > 6000 mm   | Class 2                                | Class 2                                | –  |
| <b>Resistance to water penetration</b><br>(EN 12425)   | Class 1                                | Class 1                                | –  |
| <b>Air permeability</b><br>(EN 12426)  | Class 2                                | Class 2                                | –  |
| <b>Acoustic insulation<sup>2)</sup> in dB</b><br>(EN 717-1, EN ISO 10140-1, EN ISO 10140-2)        | 26                                     | 26                                     | 31   |
| <b>RC2 break-in resistance</b><br>(acc. to DIN / TS 18194)   | ●                                      | –                                      | –  |
| <b>Counterbalance</b>  |  |  |  |
| Chain mechanism and springs  | ●                                      | –                                      | ●  |
| Belt mechanism and counter weights   | ■                                      | –                                      | –  |
| Without counterbalance   | □                                      | ●                                      | –  |
| <b>Emergency opening</b>   |  |  |  |
| Emergency hand chain   | ●                                      | ●                                      | ●  |
| Automatic door opening via UPS in case of power failure  | ○                                      | –                                      | –  |

● = Standard

○ = Optional

■ = Standard up to 5000 mm width and 5000 mm height

□ = Standard up to 3000 mm width and 3000 mm height

LDH = Clear passage height

<sup>1)</sup> Door size 4000 × 4000 mm, without glazing with ThermoFrame

<sup>2)</sup> Without glazing



| HS 5015 PU N 42   | HS 5015 PU H 42   | HS 5015 Acoustic H  | HS 6015 PU V 42   | HS 6015 Acoustic V  |
|---|---|---|---|---|
| Track application N (normal)  | Track application H (high-lift)   | Track application H (high-lift)   | Track application V (vertical)  | Track application V (vertical)  |
| Steel sandwich construction,<br>PU-foamed<br>42<br>250<br>Micrograin / Stucco<br>RAL 9006<br>○<br>○ | Steel sandwich construction,<br>PU-foamed<br>42<br>250<br>Micrograin / Stucco<br>RAL 9006<br>○<br>○ | Aluminium hollow profile,<br>5 mm UPVC / 30 mm PU<br>42<br>225<br>Smooth<br>C0 anodised<br>-<br>- | Steel sandwich construction,<br>PU-foamed<br>42<br>250<br>Micrograin / Stucco<br>RAL 9006<br>○<br>○ | Aluminium hollow profile,<br>5 mm UPVC / 30 mm PU<br>42<br>225<br>Smooth<br>C0 anodised<br>-<br>- |
| Interior / exterior   | Interior / exterior   | Interior / exterior   | Interior / exterior   | Interior / exterior   |
| 5000<br>6500<br>480   | 5000<br>6500<br>750   | 5000<br>5000<br>1000  | 6500<br>6500<br>LDH + 585   | 5000<br>5000<br>LDH + 585   |
| 1.5 – 2.5<br>0,5  | 1.5 – 2.5<br>0,5  | 1.5 – 2.5<br>0,5  | 1.5 – 2.5<br>0,5  | 1.5 – 2.5<br>0,5  |
| AK 500 FUE-1  | AK 500 FUE-1  | AK 500 FUE-1  | AK 500 FUE-1  | AK 500 FUE-1  |
| ●   | ●   | ●   | ●   | ●   |
| 1,04  | 1,04  | -   | 1,04  | -   |
| Class 5<br>Class 4<br>Class 2   | Class 5<br>Class 4<br>Class 2   | Class 4<br>-<br>-   | Class 5<br>Class 4<br>Class 2   | Class 4<br>-<br>-   |
| Class 1   | Class 1   | -   | Class 1   | -   |
| Class 2   | Class 2   | -   | Class 2   | -   |
| 26  | 26  | 31  | 26  | 31  |
| -   | -   | -   | -   | -   |
| ●<br>-<br>-   | -<br>●<br>-   | -<br>●<br>-   | -<br>●<br>-   | -<br>●<br>-   |
| ●<br>○  | ●<br>○  | ●<br>-  | ●<br>○  | ●<br>-  |

All colours based on RAL

# Spiral doors and high-speed sectional doors

## High-speed sectional door IsoSpeed Cold 100

| Door type   | IsoSpeed Cold H 100   | IsoSpeed Cold V 100            |
|---|---|--------------------------------|
| <b>Door hardware</b>  | Track application H (high-lift)                                     | Track application V (vertical) |
| <b>Suitable application</b>   | Interior  | Interior                       |
| <b>Size range</b>   |   |                                |
| Max. width (mm)   | 5000  | 5000                           |
| Max. height (mm)  | 5000  | 5000                           |
| Min. required headroom (mm)   | 750   | LDH + 585                      |
| <b>Speed</b>  |   |                                |
| Max. opening (m/s)  | 1.5 – 2.0   | 1.5 – 2.0                      |
| Closing approx. (m/s)   | 0,5   | 0,5                            |
| <b>Control</b>  |   |                                |
| Standard  | ●   | ●                              |
| <b>Safety</b>   |   |                                |
| Light grille with emergency stop / soft stop function   | ●   | ●                              |
| <b>Thermal insulation U-value in W/(m<sup>2</sup>·K)</b><br>(EN 13241-1, Appendix B EN 12428) |   |                                |
| 2000 × 2000 mm <sup>1)</sup>  | 0,90  | 0,90                           |
| 3000 × 3000 mm <sup>1)</sup>  | 0,68  | 0,68                           |
| 4000 × 4000 mm <sup>1)</sup>  | 0,57  | 0,57                           |
| 5000 × 5000 mm <sup>1)</sup>  | 0,50  | 0,50                           |
| Section   | 0,24  | 0,24                           |
| <b>Temperature range<sup>2)</sup></b>   |   |                                |
| <b>1</b>  | Fitting side > 0 °C, opposite side max. -28 °C                      |                                |
| <b>2</b>  | Fitting side 0 °C to max. -28 °C, opposite side 0 °C to max. -28 °C |                                |
| <b>Resistance to wind load</b><br>(EN 12424)  | Class 5   | Class 5                        |
| <b>Resistance to water penetration</b><br>(EN 12425)  | Class 3   | Class 3                        |
| <b>Air permeability</b><br>(EN 12426)   | Class 3   | Class 3                        |
| <b>Counterbalance</b>   |   |                                |
| Belt mechanism  | ●   | ●                              |

● = Standard ○ = Optional

<sup>1)</sup> Door surface of fitted door

<sup>2)</sup> Deviating temperatures on request

<sup>3)</sup> For a door surface of 5000 × 5000 mm

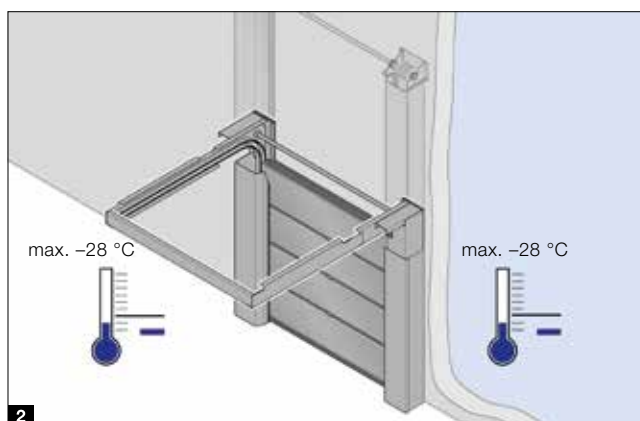
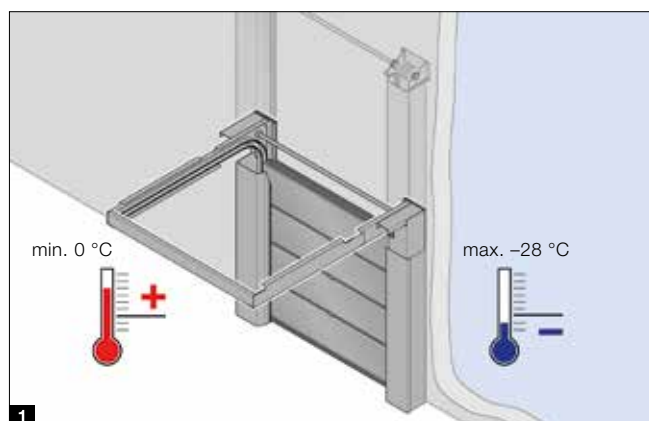



### **IsoSpeed Cold 100**

The IsoSpeed Cold 100 with its 100 mm thick sections with thermal break offers excellent insulation with a U-value of  $0.50 \text{ W}/(\text{m}^2\text{K})^3$ . Doors with a high-lift H or vertical-lift V door leaf are perfectly suited to refrigerated and cold store areas. The sections come Stucco-textured **3** on the interior and exterior, in Grey white based on RAL 9002, optionally also in 200 colours based on RAL.

### **ThermoFrame**

The ThermoFrame **4** separates the side element from the building structure. The thermal break along with additional seals improves thermal insulation and prevents thermal bridges.

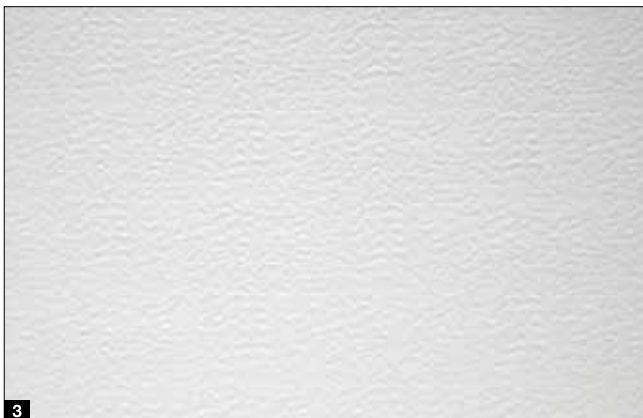

# Spiral doors and high-speed sectional doors

## High-speed sectional door IsoSpeed Cold 100

### Standard equipment **1**

By using extremely durable flat belts, which are also used in the elevator industry, we guarantee a service life of up to 500000 cycles when fitted properly. Operator support via counter weights also convinces with lower maintenance costs, as no springs have to be serviced.

### Frequency converter control **2**

High opening and closing speeds guarantee optimised workflows and temperature levels between the cold store and other temperature areas. The soft start and soft stop take stress off the mechanical door elements, enabling nearly wear-free, quiet door travel. This greatly extends the service life of the door.

### Integrated heating **3**

For safe and reliable operation, the IsoSpeed Cold 100 is equipped with heated side elements, bottom plate, operator, control housing and sealing frame as standard.

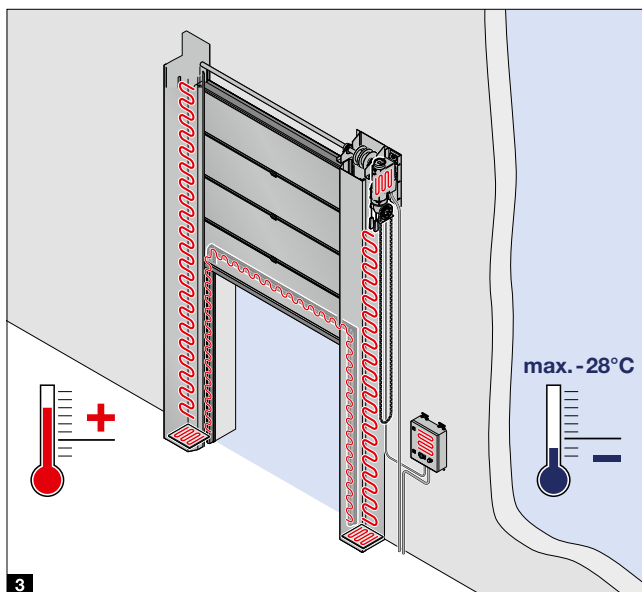

## On-site services

### Connecting lead for heating **1**

The standard heating in the side frames remains active even when the door main switch is actuated, preventing icing. A second electric cable to the door is required to supply the heating with power.

### Floor heating system **2**

A floor heating system effectively prevents the door leaf from freezing. This system is required in the closing zone to cover the entire opening area of the door and the frame depth, as well as approx. another 200 mm.

### Air curtain **3**

An air curtain minimises the temperature increase in the cold store area. It is installed on the warmer side to effectively reduce the flow of air to the cold side of the opening.

#### TIP.

Install a cold air curtain, as it is more efficient than a hot air curtain.

### Air dehumidifier **4**

For effective reduction of humidity in case of high temperature differences and high humidity, we recommend fitting an air dehumidifier on the warmer side to minimise ice formation in the cold store area.

#### NOTE.

Please contact the responsible Hörmann regional sales office, providing information on temperatures and humidity, for a precise assessment of the fitting situation.

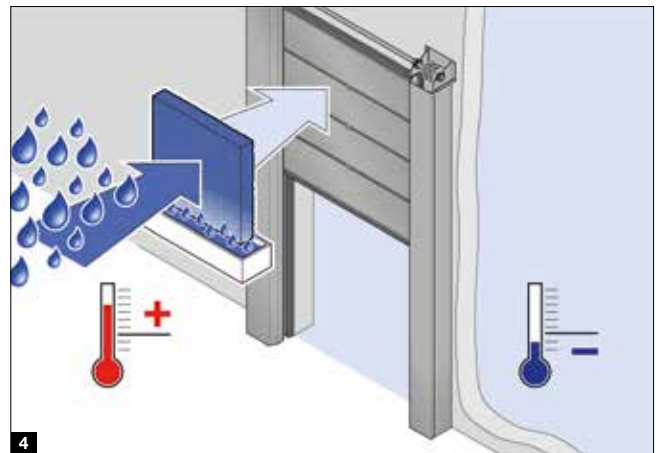
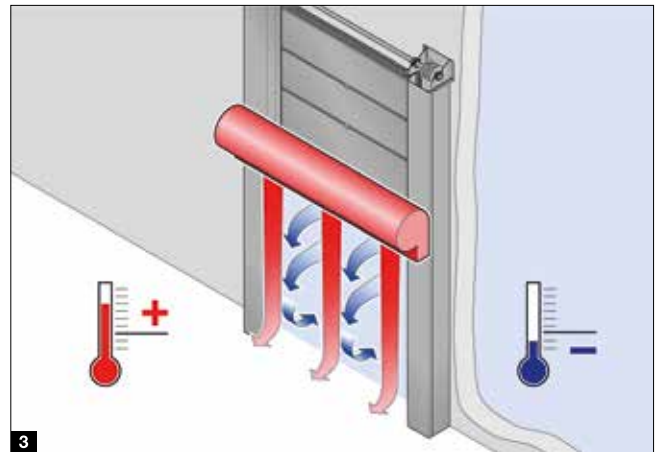
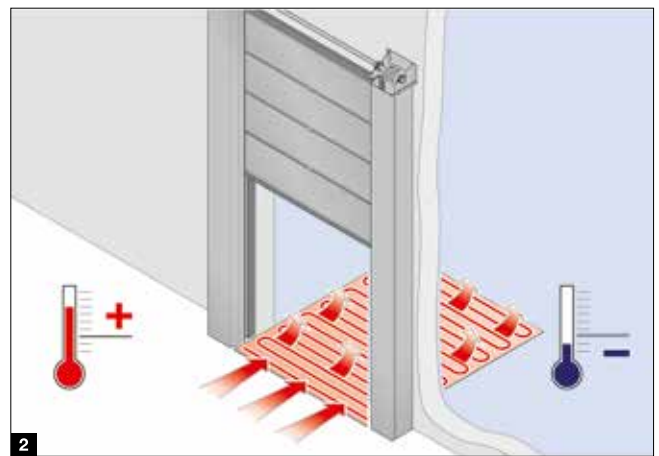
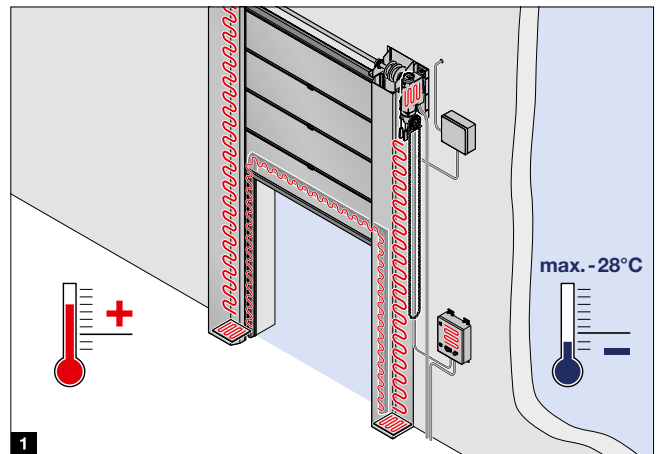

# High-speed doors with flexible door leaf

Internal doors with innovative tubular drive and aluminium side elements

| Door type   | V 4020 SEL Alu-R .NEW |
|---|-----------------------|
| <b>Suitable application</b>                             | Interior              |
| <b>Size range</b>                                       |                       |
| Max. width (mm)   | 4000                  |
| Max. height (mm)  | 4500                  |
| <b>Speed</b>  |                       |
| Max. opening (m/s)                                      | 2,0                   |
| Closing approx. (m/s)                                   | 0,8                   |
| <b>Control</b>  |                       |
| Standard  | BK 150 FUE-1          |
| <b>Safety</b>   |                       |
| Light grille with emergency stop / soft stop function   | ●                     |
| <b>Temperature range</b>                                | +5 °C to +40 °C       |
| <b>Curtain</b>  | PVC                   |
| Fabric thickness (mm)                                   | 1,5                   |
| Vision field thickness (mm)                             | 2,0                   |
| Fly-protection section                                  | ○                     |
| <b>Curtain colours</b>                                  |                       |
| Standard colours  | ●                     |
| Preferred colours                                       | ○                     |
| <b>Wind locks</b>                                       |                       |
| Spring steel with side twin rollers                     | ●                     |
| <b>Bottom profile</b>                                   |                       |
| SoftEdge  | ●                     |
| Aluminium   | ○                     |
| <b>Emergency opening</b>                                |                       |
| Manual door opening using 1/2 inch square socket        | ●                     |
| Automatic door opening via UPS in case of power failure | ○                     |

● = Standard ○ = Optional

All colours based on RAL

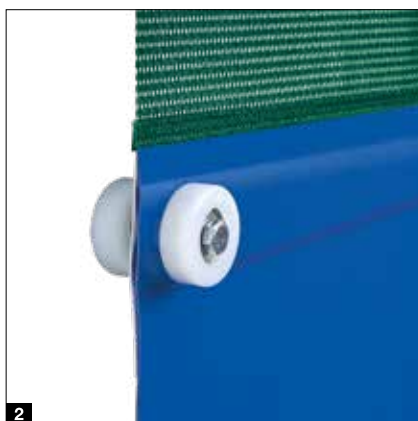
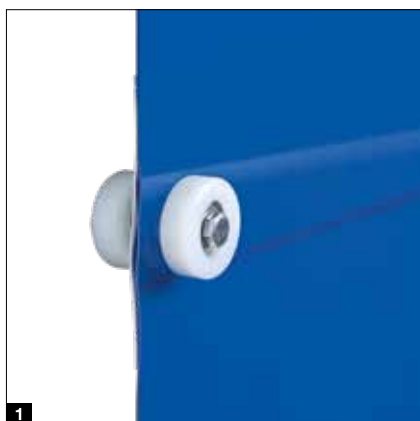

### Door type V 4020 SEL Alu-R .NEW

Thanks to the anodised aluminium surface finish of the side elements and top plates, the standard shaft cover in White aluminium RAL 9006, the integrated wiring and few visible screw fittings, the door is very elegant and is the optimum choice for use in areas with customer traffic. For a high safety level, the door features a light grille as standard which stops the door immediately if a person or vehicle is in the door opening.

The flexible SoftEdge bottom profile prevents downtime due to damage to the door system. You can also optionally obtain the V 4020 SEL Alu-R with aluminium bottom profile for wind class 3 (DIN EN 12424).

The door is fully sealed thanks to the very small gap dimensions of side elements and lip seals. The high-speed door is particularly suitable for confined fitting situations in high frequency areas thanks to the narrow side elements and the powerful tubular drive.

If the control has to be fitted in the top section due to space limitations, an optional control element can be elegantly integrated into the side frame. The control element allows for the operation of all control functions such as opening and closing as well as service settings. Emergency opening takes place via a 1/2 inch drive. The socket SW10 (long) is concealed in the top plate.

### Equipment features

- Curtain stability thanks to stabilising spring steel wind lock **1**
- Optional fly-protection curtain instead of the vision field **2**
- Shaft cover in White aluminium RAL 9006 **3**
- Powerful with tubular drive for up to 1.5 million door cycles in high use areas **4**
- Convenient operation with optional control element (80 × 120 mm) for integration in the side frame at a height of 1300 mm **5**
- High tightness thanks to small frame gap dimensions and lip seals **6**

### Optional equipment Clean

- Minimises pressure loss in rooms with differential pressures up to 30 Pa
- Robust aluminium bottom profile
- Additional sealing lip in the cladding
- Inspection openings in the cladding to facilitate door service and maintenance



# High-speed doors with flexible door leaf

Internal doors with drive belt operator and integrated control

|                                     |                                    |
|-------------------------------------|------------------------------------|
| <b>Door type</b>                    | <b>V 3010</b>                      |
| <b>Suitable application</b>         | Interior                           |
| <b>Size range</b>                   |                                    |
| Max. width (mm)                     | 3000                               |
| Max. height (mm)                    | 3000                               |
| <b>Speed</b>                        |                                    |
| Max. opening (m/s)                  | 1,0                                |
| Closing approx. (m/s)               | 1,0                                |
| <b>Control</b>                      |                                    |
| Standard                            | AKE 370 M-I                        |
| Optional                            | AKE 370 M, BK 370 M FUE-1          |
| <b>Safety</b>                       |                                    |
| Photocell                           | ●                                  |
| <b>Temperature range</b>            | +5 °C to +40 °C                    |
| <b>Curtain</b>                      | PVC, fibreglass composite material |
| Fabric thickness (mm)               | 1,0                                |
| Vision field                        | ○                                  |
| <b>Curtain colours</b>              |                                    |
| Standard colours                    | ●                                  |
| Preferred colours                   | ○                                  |
| <b>Side element colours</b>         |                                    |
| Galvanized                          | ●                                  |
| Standard colours, coated            | ○                                  |
| Special colours, coated             | ○                                  |
| Stainless steel                     | ○                                  |
| <b>Bottom profile</b>               |                                    |
| No downtimes resulting from a crash | ●                                  |

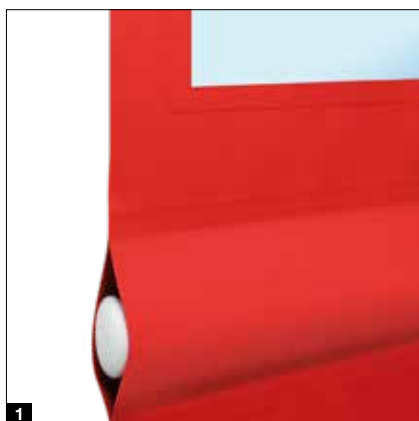



### Door type V 3010

This cost-effective entry-level door is designed for the food industry as well as for retail and logistics companies that value space-saving door solutions. Thanks to the compact construction with integrated control, shelving systems can be placed right up to the frame. As standard, the door is equipped with barrel and frame covering as well as a motor cover. The drive belt makes the operator especially compact, quiet and maintenance-friendly. A photocell with two light beams ensures reliable function and safety.

### Service-friendly integrated control

The entire control, including the control elements, is integrated in the side frame, saving space. During installation and service, the panel can simply be tilted forwards, providing easy access to all the components.

### No downtimes resulting from a crash

In the event of a crash, the floor rail of the curtain is forced out of the black PE side guides. The curtain is then automatically reinserted and the door can be operated again.

### Easy fitting

The self-supporting construction can also be fitted in tight spaces without any particular structural requirements. In addition, the construction is pre-assembled up to 80%, saving time during fitting.

### Equipment features

- 1 x PVC curtain with optional window elements **1**
- Space-saving, integrated control including buttons in the frame **2**
- Service-friendly opening of the integrated control **3**



### Individual designs

The V 3010 is available in 5 standard and 6 special colours, as well as with individual printing over the entire surface.

### Stainless steel version

For hygienic areas in the food industry, the door is also available in stainless steel and with external control AKE 370 M (IP 65, jet-water protected).



Watch the video on YouTube or at [www.hormann.co.uk/media-centre](http://www.hormann.co.uk/media-centre)

# High-speed doors with flexible door leaf

Internal doors with SoftEdge and anti-crash

| Door type   | V 4008 SEL      | V 5015 SEL      | V 5030 SEL      |
|---|-----------------|-----------------|-----------------|
| <b>Suitable application</b>                             | Interior        | Interior        | Interior        |
| <b>Size range</b>                                       |                 |                 |                 |
| Max. width (mm)   | 4000            | 5000            | 5000            |
| Max. height (mm)  | 4000            | 5000            | 5000            |
| <b>Speed</b>  |                 |                 |                 |
| Max. opening (m/s)                                      | 0,8             | 1,5             | 2,0             |
| Closing approx. (m/s)                                   | 0,8             | 0,8             | 0,8             |
| <b>Control</b>  |                 |                 |                 |
| Standard  | AKE light       | BK 150 FUE-1    | BK 150 FUE-1    |
| <b>Temperature range</b>                                | +5 °C to +40 °C | +5 °C to +40 °C | +5 °C to +40 °C |
| <b>Curtain</b>  |                 |                 |                 |
| Fabric thickness (mm)                                   | PVC<br>1,5      | PVC<br>1,5      | PVC<br>1,5      |
| Vision field thickness (mm)                             | 2,0             | 2,0             | 2,0             |
| Fly-protection section                                  | -               | ○               | ○               |
| <b>Curtain colours</b>                                  |                 |                 |                 |
| Standard colours  | ●               | ●               | ●               |
| Preferred colours                                       | ○               | ○               | ○               |
| <b>Wind locks</b>                                       |                 |                 |                 |
| Curtain slide   | ●               | -               | -               |
| Aluminium profiles                                      | -               | ●               | -               |
| Spring steel with side twin rollers                     | -               | -               | ●               |
| <b>Bottom profile</b>                                   |                 |                 |                 |
| SoftEdge  | ●               | ●               | ●               |
| Aluminium for wind load class 1                         | -               | -               | ○               |
| <b>Emergency opening</b>                                |                 |                 |                 |
| Emergency crank handle                                  | ●               | ●               | ●               |
| Emergency hand chain                                    | -               | ○               | ○               |
| Automatic door opening via UPS in case of power failure | -               | ○               | ○               |

● = Standard ○ = Optional

All colours based on RAL

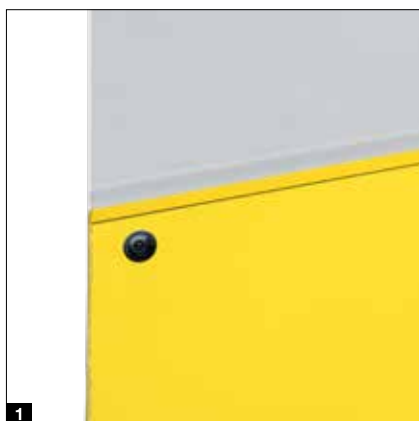

### Door type V 4008 SEL

This especially cost-effective internal door is ideal for areas without draughts and is equipped with an AK E control. The standard safety equipment with SoftEdge, radio crash switch and safety light curtain in the closing edge zone offers maximum safety in day-to-day operation.

#### Equipment features

- Curtain with curtain slide **1**
- Optional vision fields **1**

### Door type V 5015 SEL

This internal door for areas without draught comes with safety functions such as SoftEdge and light grille with emergency stop / soft stop function as standard. The aluminium wind lock also makes the door particularly service-friendly, since curtain segments can be quickly replaced if repairs are necessary. For an improved view the curtain is also available with two transparent curtain sections.

#### Equipment features

- Curtain stability with aluminium profiles **2**
- Optional fly-protection curtain instead of the vision field **3**

### Door type V 5030 SEL

Draughts always pose a particular challenge for doors. With the robust wind locks made of spring steel, the V 5030 SEL remains stable under small pull and wind loads. You can also optionally obtain the V 5030 SEL with aluminium bottom profile for wind class 1 (DIN EN 12424).

#### Equipment features

- Spring steel wind lock for quiet door travel **4**
- Optional fly-protection curtain instead of the vision field **5**

#### Replacement section for V 5030 SEL and V 6030 SEL .NEW

The area directly above the bottom profile is the area that is most often damaged by a collision with the forklift truck. If you require a spare part, the complete curtain must then be replaced.

The 300 mm high replacement section **6** is located directly above the bottom profile and is connected to the remaining curtain area by means of a weather strip profile. If collision damage occurs, only this small section needs to be replaced. In addition to material costs, this also saves fitting costs, since the replacement requires far less time and effort. The replacement section is available in the standard colours and in black.



# High-speed doors with flexible door leaf

Internal and external doors

| Door type   | V 6030 SEL          | V 6020 TRL  | V 10008                 |
|---|---------------------|---|-------------------------|
| <b>Suitable application</b>                               | Interior / exterior | Interior / exterior                                     | Interior / exterior     |
| <b>Size range</b>   |                     |   |                         |
| Max. width (mm)   | 5000                | 6000  | 10000                   |
| Max. height (mm)  | 6000                | 7000  | 6250                    |
| <b>Speed</b>  |                     |   |                         |
| Max. opening (m/s)  | 2,0                 | 2,0   | 1.5 (0.8) <sup>3)</sup> |
| Closing approx. (m/s)                                     | 0,8                 | 0,5   | 0,4                     |
| <b>Control</b>  |                     |   |                         |
| Standard  | BK 150 FUE-1        | BK 150 FUE-1 <sup>1)</sup> , AK 500 FUE-1 <sup>2)</sup> | AK 500 FUE-1            |
| <b>Safety</b>   |                     |   |                         |
| Light grille with emergency stop / soft stop function     | ●                   | ●   | ●                       |
| <b>Resistance to wind load (EN 12424)</b>                 |                     |   |                         |
| Door width ≤ 4000 mm                                      | Class 2             | Class 2   | Class 4                 |
| Door width > 4000 mm ≤ 5000 mm                            | Class 2             | Class 2   | Class 3                 |
| Door width > 5000 mm                                      |                     | Class 2   | Class 2                 |
| <b>Temperature range</b>                                  | +5 °C to +40 °C     | +5 °C to +40 °C   | +5 °C to +40 °C         |
| <b>Curtain</b>  | PVC                 | PVC   | PVC                     |
| Fabric thickness (mm)                                     | 1,5                 | 2,4   | 1,5                     |
| Vision field thickness (mm)                               | 2,0                 | 4,0   | 2,0                     |
| Fully transparent curtain (mm)                            |                     | 4,0   |                         |
| Fly-protection section                                    | ○                   | -   | -                       |
| <b>Curtain colours</b>                                    |                     |   |                         |
| Standard colours  | ●                   | ● <sup>4)</sup>   | ●                       |
| Preferred colours   | ○                   | ○   | ○                       |
| <b>Wind locks</b>   |                     |   |                         |
| Spring steel with side twin rollers and tensioning system | ●                   | ●   | ●                       |
| <b>Bottom profile</b>                                     |                     |   |                         |
| SoftEdge  | ●                   | -   | -                       |
| Aluminium   | -                   | ●   | ●                       |
| <b>Emergency opening</b>                                  |                     |   |                         |
| Emergency crank handle                                    | ●                   | ●   | -                       |
| Emergency hand chain                                      | ○                   | ○   | ●                       |
| Automatic door opening via UPS in case of power failure   | ○                   | ○   | -                       |

● = Standard ○ = Optional

All colours based on RAL

<sup>1)</sup> Up to 95 kg

<sup>2)</sup> From 95 kg

<sup>3)</sup> From 6000 mm door width

<sup>4)</sup> Wind lock strips and / or fabric colour (RAL 1018, RAL 3002 only for wind lock strips)

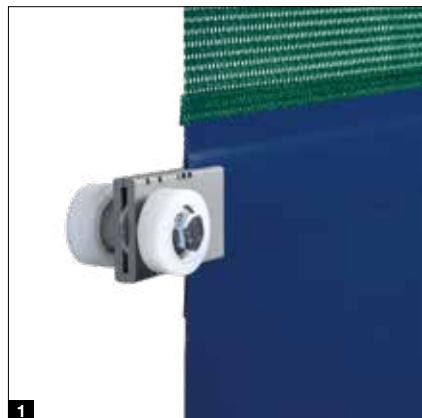

### Door type V 6030 SEL

When the SoftEdge door is used outside, collision damage in everyday work generally does not have any serious effects. Pull and wind loads do not pose problems thanks to the spring steel wind lock. You can also optionally obtain the V 6030 SEL with aluminium bottom profile.

#### Equipment features

- Stabilising spring steel wind lock with optional fly-protection curtain **1**
- Tensioning system for reliable door travel **2**
- Optional replacement section (for further information, see page 51)

### Wind kit .NEW

The optional wind kit improves the resistance to wind load. The set consists of a particularly robust aluminium bottom profile **3** with a 600 mm high replacement section for cost-efficient repair in case of collision damage. It is available in 6 RAL colours. Two 3D laser scanners with state-of-the-art laser technology for optimal advance protection and safe opening complete the set.

### Door type V 6020 TRL

The 4-mm-thick, transparent door curtain allows light to pass through and protects against surprises during transport. Optionally, the curtain with coloured fabric material with or without vision field is available. From a door surface of 25 m<sup>2</sup>, we supply the curtain in a coloured fabric material with vision field as standard.

#### Equipment features

- Transparent curtain for more light and visual contact **4**
- Optional fabric curtain with vision field (also available without vision field) **5**

### Door type V 10008

The external door was specifically developed for large openings and high wind loads. Double lashing straps, lateral twin rollers and especially wide side guides ensure safe door travel even with a high door curtain weight. The spring steel wind locks also allow for wind loads of up to 100 km/h.

#### Equipment features

- Stabilising spring steel wind lock **6**



# High-speed doors with flexible door leaf

Internal doors for special applications

| Door type   | V 4015 Iso L                                   | V 2515 Food L   | V 2012          |
|---|--|-----------------|-----------------|
| <b>Suitable application</b>                             | Interior                                       | Interior        | Interior        |
| <b>Size range</b>                                       |  |                 |                 |
| Max. width (mm)   | 4000   | 2500            | 2500            |
| Max. height (mm)  | 4500   | 4000            | 2500            |
| <b>Speed</b>  |  |                 |                 |
| Max. opening (m/s)                                      | 1,5  | 1,2             | 1,2             |
| Closing approx. (m/s)                                   | 0,5  | 0,5             | 0,5             |
| <b>Thermal insulation (EN 13241-1, ISO 12567-1)</b>     |  |                 |                 |
| U-value in W/(m <sup>2</sup> ·K)                        | 1,6  | -               | -               |
| <b>Control</b>  |  |                 |                 |
| Standard  | BK 150 FUE-1                                   | BK 150 FUE-1    | BK 150 FUE-1    |
| <b>Temperature range</b>                                | +1 °C to +40 °C                                | +5 °C to +40 °C | +5 °C to +40 °C |
| <b>Curtain</b>  | Insulating curtain with a 20 mm PE foam infill | PVC             | PVC             |
| Fabric thickness (mm)                                   | -  | 1,5             | 1,5             |
| Vision field thickness (mm)                             | 2.0 <sup>1)</sup>                              | 2,0             | 2,0             |
| Fully transparent curtain (mm)                          | -  | -               | -               |
| <b>Curtain colours</b>                                  |  |                 |                 |
| Standard colours  | ● <sup>2)</sup>                                | ●               | ●               |
| Preferred colours                                       | -  | ○               | ○               |
| <b>ThermoFrame</b>                                      | ○  | -               | -               |
| <b>Wind locks</b>                                       |  |                 |                 |
| Aluminium profile                                       | ●  | -               | -               |
| Curtain slide   | -  | -               | ●               |
| Spring steel  | -  | ●               | -               |
| <b>Bottom profile</b>                                   |  |                 |                 |
| SoftEdge  | -  | ●               | ●               |
| Aluminium   | ●  | -               | -               |
| <b>Emergency opening</b>                                |  |                 |                 |
| Emergency crank handle                                  | ●  | -               | -               |
| Counter weight with operating current brake             | -  | -               | ●               |
| Automatic door opening via UPS in case of power failure | ○  | ○               | -               |

● = Standard ○ = Optional

All colours based on RAL

<sup>1)</sup> Only one vision field with a height of approx. 230 mm possible per door

<sup>2)</sup> Only in RAL 7038

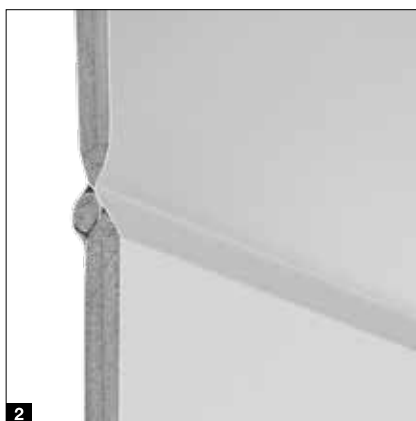
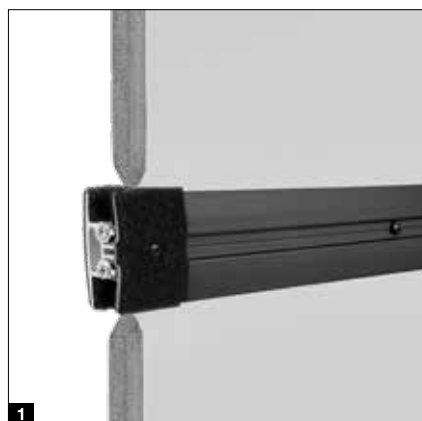

### Door type V 4015 Iso L

The door with energy-efficient insulated curtain is the perfect solution for internal areas for cold and fresh logistics (up to +5 °C). The optional ThermoFrame separates the frame from the building structure, thus improving thermal insulation by up to 15%.

#### Equipment features

- Stabilising wind lock **1**
- PE foam in curtain pockets **2**
- Optional vision fields

### Door type V 2515 Food L

The side guides of this door, specifically designed for the food industry, are particularly easy to clean **5**. High-pressure cleaning systems and water are not a problem for the door construction, which is made entirely of stainless steel. No counter weights or springs complicate the cleaning of the frame.

#### Equipment features

- Standard EPDM seal **3**
- Shaft, side elements and control box made of stainless steel

### Door type V 2012

Full equipment with operator and shaft cover, standard light grille (monitoring height 350 mm) and automatic emergency opening via a counter weight (in case of power failure) make this flexible plastic curtain door a safe choice for indoor areas with a high customer frequency.

#### Equipment features

- Light grille concealed in the door guide **4**
- Optional custom imprint **6**



# High-speed doors with flexible door leaf

Internal doors for individual needs

| Door type   | V 5030 MSL  | V 3009 Conveyor | V 3015 Clean    |
|---|---|-----------------|-----------------|
| <b>Suitable application</b>                             | Interior  | Interior        | Interior        |
| <b>Size range</b>                                       |   |                 |                 |
| Max. width (mm)   | 4000  | 3500            | 2500            |
| Max. height (mm)  | 4000  | 3500            | 3000            |
| <b>Speed</b>  |   |                 |                 |
| Max. opening (m/s)                                      | 1,5   | 0.8 (1.2)       | 1,5             |
| Closing approx. (m/s)                                   | 0,8   | 0.8 (0.5)       | 0,5             |
| <b>Control</b>  |   |                 |                 |
| Standard  | BK 150 FUE-1 <sup>1)</sup> , AK 500 FUE-1 <sup>2)</sup> | AKE             | BK 150 FUE-1    |
| Optional  | –   | BK 150 FUE-1    |                 |
| <b>Safety</b>   |   |                 |                 |
| Light grille  | ●   | –               |                 |
| Closing edge safety device, one-way photocell           | –   | ●               |                 |
| <b>Resistance to wind load (EN 12424)</b>               |   |                 |                 |
| Door width ≤ 4000 mm                                    | Class 1   | –               | –               |
| <b>Temperature range</b>                                | +5 °C to +40 °C   | +5 °C to +40 °C | +5 °C to +40 °C |
| <b>Curtain</b>  |   |                 |                 |
| Fabric thickness (mm)                                   | PVC<br>2,4  | PVC<br>1,5      | PVC<br>–        |
| Vision field thickness (mm)                             | –   | 2,0             | –               |
| Fully transparent curtain (mm)                          | 4,0   | –               | 4,0             |
| <b>Curtain colours</b>                                  |   |                 |                 |
| Standard colours  | ● <sup>3)</sup>   | ●               | ●               |
| Preferred colours                                       | ○   | ○               | –               |
| <b>Curtain locking strips</b>                           |   |                 |                 |
| Standard colours  | –   | –               | ●               |
| <b>Wind locks</b>                                       |   |                 |                 |
| Spring steel  | ●   | –               |                 |
| Aluminium   | –   | ●               |                 |
| <b>Bottom profile</b>                                   |   |                 |                 |
| Aluminium   | ●   | ●               | ●               |
| <b>Emergency opening</b>                                |   |                 |                 |
| Emergency crank handle                                  | ●   | ●               | ●               |
| Automatic door opening via UPS in case of power failure | –   | –               | ○               |

● = Standard ○ = Optional

All colours based on RAL

<sup>1)</sup> Up to 95 kg

<sup>2)</sup> From 95 kg

<sup>3)</sup> Wind lock strips and / or fabric colour (RAL 1018, RAL 3002 only for wind lock strips)





---

### Door type V 5030 MSL

The requirements for workplace safety and production processes are constantly increasing. Short downtimes, easy and quick access for operation and maintenance of the production machines and of course the safety of the employees are all important for smooth production. Thanks to the safety sensors **1** the door can open only when the machine is idle and the machine can be operated only when the door is closed. The V 5030 MSL with fully transparent 4-mm-thick curtain was developed specifically for this application. Optionally, the curtain with coloured fabric material with vision field is available.

### Door type V 3009 Conveyor

Due to the low lateral space requirements, this door is specifically designed for integration in conveyor systems and their frequent automated opening and closing cycles. A vision field **2** gives insight into the operating procedure. The operator control can be integrated in existing PLC systems. Two volt-free contacts report the door position (Open / Closed) to the control.

### Door type V 3015 Clean

Air purification in clean rooms can result in a differential pressure of up to 50 Pa. The fully transparent curtain of the V 3015 Clean is tightly integrated in the special side guides. This minimises air loss (leakage) and enables an optimum design for ventilation systems. Thanks to the stainless steel cover on the shaft and operator, and the welded-in spring steel stabilisation, the frame is easy to clean without obstructions.

### Equipment features

- Extremely leaktight and fully transparent **3**
- Curtain tightly integrated in the side guides **4**



# High-speed folding doors

Internal, external and deep freeze doors

| Door type                                 | F 6010 / F 6010 Iso                               | F 4010 Cold                                |
|---|---|--|
| <b>Suitable application</b>               | Interior / exterior                               | Cold store area                            |
| <b>Size range</b>                         |   |  |
| Max. width (mm)                           | 6000  | Up to 4000                                 |
| Max. height (mm)                          | 6000  | Up to 5500                                 |
| <b>Speed</b>                              |   |  |
| Max. opening (m/s)                        | 1,0   | 1,0  |
| Closing approx. (m/s)                     | 1,0   | 1,0  |
| <b>Control</b>                            |   |  |
| Standard                                  | AK E  | AK E                                       |
| Optional                                  | AK 500 FUE-1 <sup>1)</sup> ,<br>AK E 2500 M-I     | AK 500 FUE-1 <sup>1)</sup> ,<br>AK E-750 M |
| <b>Safety</b>                             |   |  |
| Light grille                              | ●   | -  |
| Photocell                                 | -   | ●  |
| Closing edge safety device                | ○   | -  |
| <b>Resistance to wind load (EN 12424)</b> |   |  |
| Class 3                                   | ●   | -  |
| Class 4                                   | ○   | -  |
| <b>Temperature range</b>                  | -5 °C to +40 °C<br>-30 °C to +40 °C <sup>2)</sup> | -30 °C to +15 °C                           |
| <b>Curtain</b>                            | PVC, spring steel wind locks                      | 3× PVC, fibreglass composite material      |
| Fabric thickness (mm)                     | 1,0   | 1,0  |
| Vision field                              | ○   | -  |
| <b>Curtain colours</b>                    |   |  |
| Standard colours                          | ●   | ●  |
| Preferred colours                         | ○   | ○  |
| <b>Side element colours</b>               |   |  |
| Galvanized                                | ●   | ●  |
| Standard colours, coated                  | ●   | ●  |
| Special colours, coated                   | ○   | ○  |
| Stainless steel                           | ○   | ○  |
| <b>Side elements</b>                      |   |  |
| Flexible guide belts                      | ●   | ●  |

● = Standard ○ = Optional

<sup>1)</sup> Max. 60 cycles per hour

<sup>2)</sup> With optional heating in the operator for outside applications

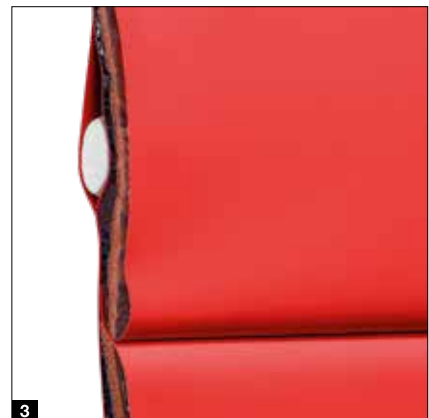

### Door type F 6010

The stable steel wind reinforcement laths are arranged at 600 mm intervals across the entire height of the door and enable reliable operation up to wind load class 3 (optionally up to wind load class 4).

#### Equipment features

- 1x PVC curtain with standard spring steel wind locks and optional window elements **1**
- Flexible guide belts prevent downtime after a crash **4**
- Optional integrated control AK E 2500 M-I **5**

### Door type F 6010 Iso\*

For improved thermal insulation, we recommend the F 6010 Iso with an insulated curtain. With an optional heated operator F 6010 Iso can be used up to -30 °C.

#### Equipment features

- Improved thermal insulation due to the insulated curtain **2**
- Flexible guide belts prevent downtime after a crash **4**
- Optional integrated control AK E 2500 M-I **5**



Watch the video on YouTube or at [www.hormann.co.uk/media-centre](http://www.hormann.co.uk/media-centre)

### Door type F 4010 Cold

The flexible high-speed folding door F 4010 Cold is the optimal solution for all interior areas in cold store logistics. The triple-insulated curtain reliably reduces cooling losses in cold store areas and the opening speed of 1 m/s ensures the rapid flow of traffic for maintaining the cold chain.

#### Equipment features

- 3x insulated curtain for reducing cooling losses **3**
- Flexible guide belts prevent downtime after a crash **4**
- Heated frames for use in cold store areas with temperatures down to -30 °C **6**

#### Note:

Useful optional extras provided on site, such as underfloor heating, air curtain systems or dehumidifiers, ensure the reliable function of the high-speed folding doors.

\* Not for use as a deep freeze door



Watch the video on YouTube or at [www.hormann.co.uk/media-centre](http://www.hormann.co.uk/media-centre)



# High-speed folding doors

Internal, external and deep freeze doors

| Door type                                 | F 8005                       | F 14005                      |
|---|------------------------------|------------------------------|
| <b>Suitable application</b>               | Interior / exterior          | Interior / exterior          |
| <b>Size range</b>                         |                              |                              |
| Max. width (mm)                           | 8000                         | 14000                        |
| Max. height (mm)                          | 10000                        | 8500                         |
| <b>Speed</b>                              |                              |                              |
| Max. opening (m/s)                        | 0,5                          | 0,5                          |
| Closing approx. (m/s)                     | 0,5                          | 0,5                          |
| <b>Control</b>                            |                              |                              |
| Standard                                  | AK E-700 M                   | AK E-700 M                   |
| Optional                                  | -                            | -                            |
| <b>Safety</b>                             |                              |                              |
| Light grille                              | -                            | -                            |
| Photocell                                 | ●                            | -                            |
| Closing edge safety device                | -                            | ●                            |
| <b>Resistance to wind load (EN 12424)</b> |                              |                              |
| Class 2 <sup>2)</sup>                     | ●                            | ●                            |
| Class 3 <sup>2)</sup>                     | ●                            | ●                            |
| Class 4 <sup>2)</sup>                     | ●                            | ●                            |
| <b>Temperature range</b>                  | -5 °C to +40 °C              | -5 °C to +40 °C              |
| <b>Curtain</b>                            | PVC, spring steel wind locks | PVC, spring steel wind locks |
| Fabric thickness (mm)                     | 1,0                          | 1,0                          |
| Vision field                              | ○                            | ○                            |
| <b>Curtain colours</b>                    |                              |                              |
| Standard colours                          | ●                            | ●                            |
| Preferred colours                         | ○                            | ○                            |
| <b>Side element colours</b>               |                              |                              |
| Galvanized                                | -                            | -                            |
| Standard colours, coated                  | ●                            | ●                            |
| Special colours, coated                   | ○                            | ○                            |
| Stainless steel                           | -                            | -                            |
| <b>Side elements</b>                      |                              |                              |
| Flexible guide belts                      | -                            | -                            |

● = Standard ○ = Optional

All colours based on RAL

<sup>1)</sup> Max. 60 cycles per hour

<sup>2)</sup> Dependent on door size

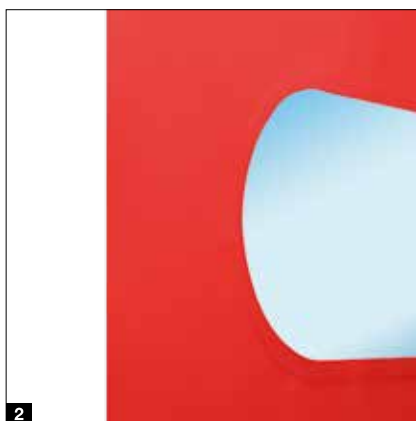
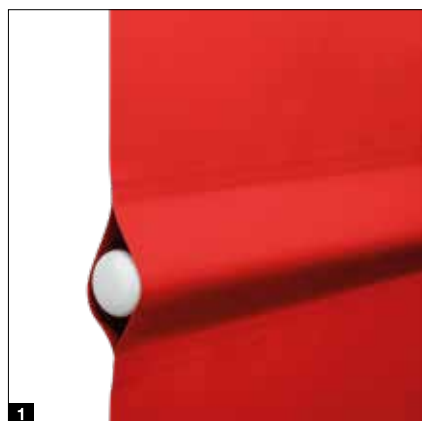

---

### Door type F 8005

For openings up to 8 m wide and 10 m high, we recommend high-speed folding door F 8005 with robust steel wind reinforcement laths and two operators connected in parallel.

#### Equipment features

- 1× PVC curtain with standard spring steel wind locks **1**
- Optional window elements **2**

### Door type F 14005

The high-speed folding door reduces energy loss and draughts at large external door openings up to 14 m wide and 8.5 m high. Up to a width of 10 m, the doors reliably withstand wind loads up to class 4 as standard. The door is equipped with two operators working in parallel.

#### Equipment features

- 1× PVC curtain with standard spring steel wind locks **1**
- Optional window elements **2**



Watch the video on YouTube or at [www.hormann.co.uk/media-centre](http://www.hormann.co.uk/media-centre)

# Individual colour schemes

For greater design freedom

## Standard colours

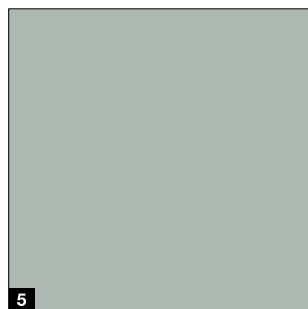
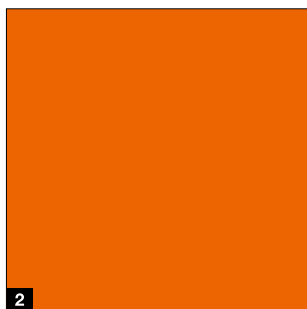
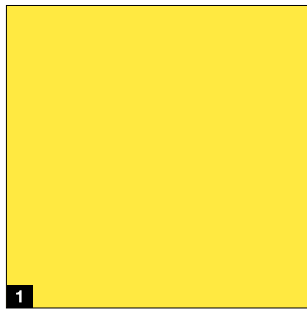

## Preferred colours

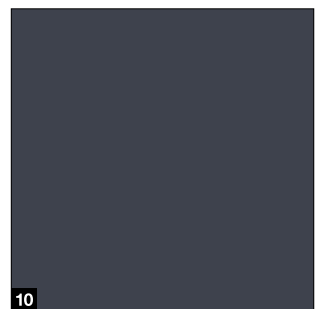
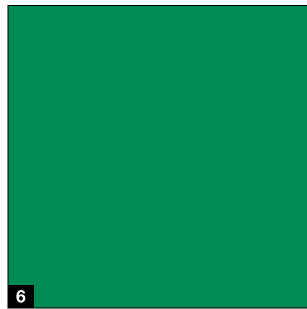

### Standard colours

- 1 RAL 1018 Zinc yellow
- 2 RAL 2004 Pure orange
- 3 RAL 3002 Carmine red
- 4 RAL 5010 Gentian blue
- 5 RAL 7038 Agate grey

### Preferred colours

- 6 RAL 6024 Traffic green
- 7 RAL 7012 Basalt grey
- 8 RAL 7016 Anthracite grey
- 9 RAL 7022 Umbra grey
- 10 RAL 7024 Graphite grey

### Door types

All high-speed doors (curtain)  
All high-speed folding doors (curtain and side elements)

### Door types

All high-speed doors (curtain) except V 3010

### Note

The colours shown are subject to the limitations of the printing process and cannot be regarded as binding. All colours based on RAL.  
Please consult with your Hörmann sales partner.

## Special colours

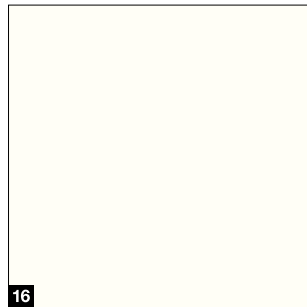
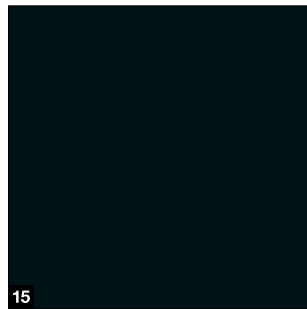
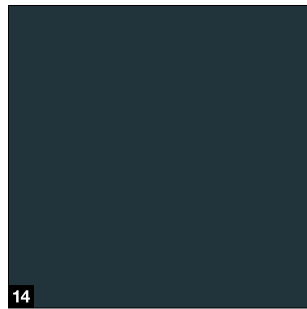
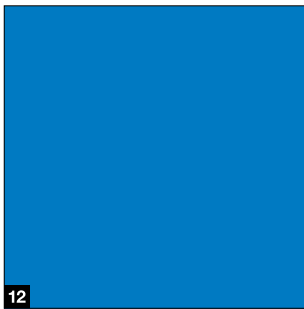
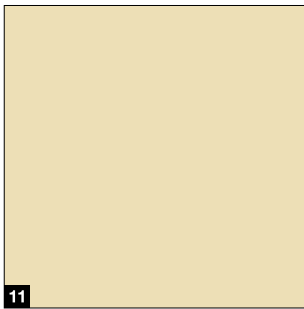

### Special colours

- 11** RAL 1015 Light ivory
- 12** RAL 5015 Sky blue
- 13** RAL 6026 Opal green
- 14** RAL 7016 Anthracite grey
- 15** RAL 9005 Jet black
- 16** RAL 9010 Pure white

### Door types

All high-speed folding doors (curtain and side elements)  
High-speed door V 3010 (curtain)

## Stainless steel

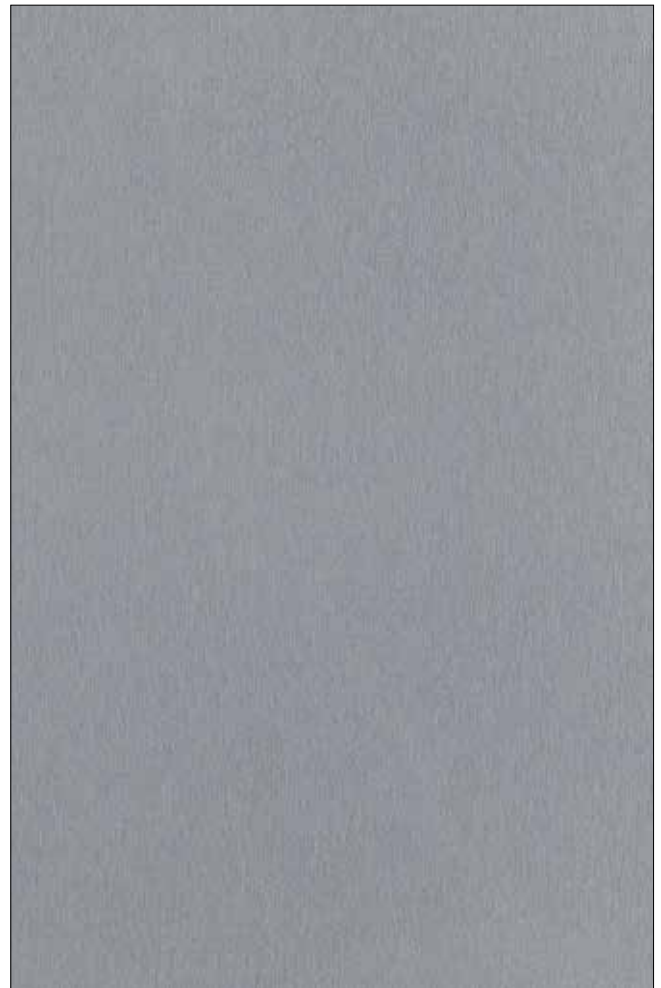

### Polished finish, K240

This surface is ground first and then brushed to refine and finish it.

### Door types

As standard for high-speed door V 2515 Food L  
(shaft, side elements, control box)  
Optional for high-speed folding doors F 6010 / F 6010 Iso,  
F 4010 Cold (side elements)

# SmartControl

All-round carefree solution for lasting reliable door function

The current generation of high-speed doors can also be integrated into digital service and remote maintenance concepts. With the SmartControl online portal, you get an all-round carefree package for robust logistics processes with regard to your door system, minimising downtime due to preventive replacement of wearing parts.



SmartControl



## Advantages at a glance

- 24/7 monitoring and technical door analysis, also remotely
- Online portal with all important door information, e.g. error messages or door cycles
- No software installation required
- Cost-savings thanks to fewer and shorter service visits
- Fast troubleshooting thanks to online access to operator control
- Fewer and shorter downtimes due to early replacement of wearing parts
- Programming menu settings
- Push messages when configured events occur, e.g. max. door cycles for service visits
- Optimisation of service and maintenance scheduling through forward planning
- Optional for all high-speed doors with the controls BK 150 FUE-1 and AK 500 FUE-1





## Reliable thanks to innovative equipment\*

Hörmann high-speed doors are up to 20 times faster than conventional industrial doors, which is why the intelligent operator and control technology is designed for reliable continuous operation.

## Frequency converter control

High performance frequency converter controls (FU) feature higher speeds and relieve the complete door mechanism which, in turn, extends the service life of the door considerably.

## Advantages at a glance

- Door cycle counter
- Operation time monitoring
- Automatic timer (adjustable hold-open phase)
- Error display / diagnosis via a 4 × 7-segment display
- Service operation setting
- Colour-coded plug-in control wiring

Easy connection of accessory components and safety devices through colour-coded plug-in connections and cables. This makes fitting for initial electrical start-up quick and easy.

\* Dependent on door version

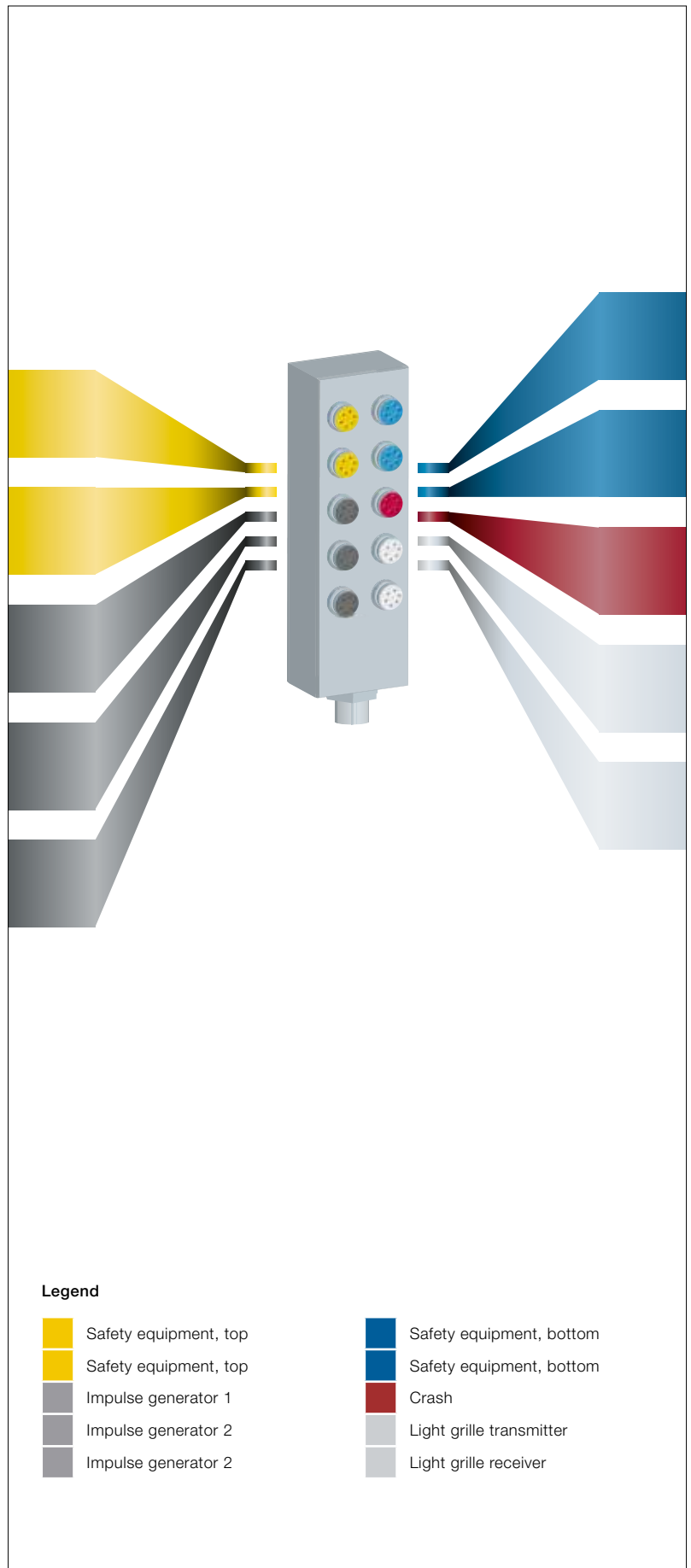

# Controls

For spiral doors and high-speed sectional doors, flexible high-speed doors and high-speed folding doors



| Controls   | BK 150 FUE-1  | AK 500 FUE-1  | AKE                             | AKE light       |
|--|---|---|---------------------------------|-----------------|
| <b>Compatible spiral doors and high-speed sectional doors</b>                            |   | All door types  |                                 |                 |
| <b>Compatible high-speed doors</b>   | V 4020 SEL Alu-R, V 5015 SEL, V 5030 SEL, V 6030 SEL, V 6020 TRL (up to 95 kg), V 5030 MSL (up to 95 kg), V 2012, V 4015 Iso L, V 3009 Conveyor, V 3015 Clean | V 10008, V 5030 SEL, V 6030 SEL, V 6020 TRL (from 95 kg), V 5030 MSL (from 95 kg) | V 3009                          | V 4008 SEL      |
| <b>Compatible high-speed folding doors</b>   |   | F 6010, F 6010 Iso, F 4010 Cold   | F 6010, F 6010 Iso, F 4010 Cold |                 |
| <b>Frequency converter control</b>   | ●   | ●   |                                 |                 |
| <b>Inversion relay control</b>   |   |   | ●                               | ●               |
| <b>Housing</b>   |   |   |                                 |                 |
| Plastic housing  | ●   | ●   | ●                               | ●               |
| Steel housing  | ○   | ○   | ○                               |                 |
| Stainless steel housing  | ○   | ○   | ○                               | ○               |
| <b>Operation</b>   |   |   |                                 |                 |
| Open / Stop / Close membrane push button   | ●   | ●   | ●                               | ●               |
| Lockable main switch   | ○   | ●   | ○ <sup>1)</sup>                 | ○ <sup>1)</sup> |
| Emergency-off button   | ○   | ●   | ●                               | ●               |
| Display, 4x, 7 segments  | ●   | ●   | ●                               | ●               |
| <b>Functions</b>   |   |   |                                 |                 |
| Automatic timer  | ●   | ●   | ●                               | ●               |
| Adjustable hold-open phase   | ●   | ●   | ●                               | ●               |
| Safety light curtain   | ●   | ●   |                                 | ●               |
| Safety photocell   |   |   | ● <sup>4)</sup>                 |                 |
| Closing edge safety device   | ● <sup>2)</sup>   | ● <sup>3)</sup>   | ●                               |                 |
| Stop / re-open   | ●   | ●   | ●                               | ●               |
| <b>Extension options</b>   |   |   |                                 |                 |
| Traffic light  | ○   | ○   | ○                               | ○               |
| Flashing warning light   | ○   | ○   | ○                               | ○               |
| Locking  | ○   | ○   | ○                               |                 |
| Intermediate stop  | ○   | ○   | ○                               |                 |
| Extension PCB  | ○   | ○   | ○                               |                 |
| <b>Protection category</b>   | IP 65   | IP 65   | IP 54                           | IP 54           |
| <b>Power supply</b>  |   |   |                                 |                 |
| Connecting lead 1~230 V, PE, 16 A, slow-acting   | ●   |   |                                 |                 |
| Connecting lead 3~400 V, PE, 10 A, slow-acting   |   |   | ●                               | ●               |
| Connecting lead 3~400 V, PE, 16 A, slow-acting   |   | ●   |                                 |                 |
| Cable set for plug-in connection between door operator and control cabinet <sup>5)</sup> | 6.5 m   | 6.5 m   | 6.5 m                           | 6.5 m           |
| Cable for on-site CEE socket   | 0.8 m, 230 V, blue  | 0.8 m, 400 V, red   | 1 m, 400 V, red                 | 1 m, 400 V, red |
| <b>Housing dimensions (without wall holder)</b>  | 230 x 460 x 200   | 230 x 460 x 200   | 180 x 320 x 100                 | 180 x 320 x 100 |

● = As standard ○ = Optional

<sup>1)</sup> Main switch only optionally available as surface-mounted version

<sup>2)</sup> For V 3015 Clean

<sup>3)</sup> For V 10008

<sup>4)</sup> Only for F6010, F6010 ISO, F4010 Cold

<sup>5)</sup> Different cable lengths optionally available on request



| Controls   | AKE 2500 M-I           | AKE 700 M         | AK E 750 M      | AKE 370 M-I            | AKE 370 M       | BK 370 M FUE-1  |
|--|------------------------|-------------------|-----------------|------------------------|-----------------|-----------------|
| <b>Compatible flexible high-speed doors</b>                                |                        |                   |                 | V 3010                 | V 3010          | V 3010          |
| <b>Compatible high-speed folding doors</b>                                 | F 6010<br>F 6010 Iso   | F 8005<br>F 14005 | F 4010 Cold     |                        |                 |                 |
| <b>Inversion relay control</b>   | ●                      | ●                 | ●               | ●                      | ●               | ●               |
| <b>Housing</b>   |                        |                   |                 |                        |                 |                 |
| Plastic housing  |                        | ●                 | ●               |                        | ●               | ●               |
| Integrated (frame)   | ●                      |                   |                 | ●                      |                 |                 |
| <b>Operation</b>   |                        |                   |                 |                        |                 |                 |
| Open / Stop / Close membrane push button                                   | ●                      | ●                 | ●               | ●                      | ●               | ●               |
| Main switch  | ●                      | ●                 | ●               | ●                      | ●               | ●               |
| Emergency-off button   | ●                      | ●                 | ●               | ●                      | ●               | ●               |
| Display  | ●                      | ●                 | ●               | ●                      | ●               | ●               |
| <b>Functions</b>   |                        |                   |                 |                        |                 |                 |
| Electronic end-of-travel position setting                                  | ●                      |                   |                 | ●                      |                 |                 |
| Automatic timer  | ●                      | ●                 | ●               | ●                      | ●               | ●               |
| Adjustable hold-open phase   |                        | ●                 | ●               |                        | ●               | ●               |
| Safety photocell   |                        | ●                 | ●               |                        | ●               | ●               |
| Stop / re-open   |                        | ●                 | ●               |                        | ●               | ●               |
| <b>Extension options</b>   |                        |                   |                 |                        |                 |                 |
| Traffic light  | ●                      | ●                 | ●               | ●                      | ●               | ●               |
| Flashing warning light   | ●                      | ●                 | ●               | ●                      | ●               | ●               |
| Locking  | ●                      | ●                 | ●               | ●                      | ●               | ●               |
| Intermediate stop  | ●                      | ●                 | ●               | ●                      | ●               | ●               |
| <b>Protection category</b>   | IP 20                  | IP 65             | IP 65           | IP 20                  | IP 65           | IP 65           |
| <b>Power supply</b>  |                        |                   |                 |                        |                 |                 |
| Connecting lead 3~400 V, PE, 10 A, slow-acting                             | ●                      | ●                 | ●               | ●                      | ●               | ●               |
| Connecting lead 3~230 V, PE, 25 A, slow-acting                             | ●                      | ●                 | ●               | ●                      | ●               | ●               |
| Cable set for plug-in connection between door operator and control cabinet | 6.5 m, 5-pin, CEE plug |                   |                 | 6.5 m, 5-pin, CEE plug |                 |                 |
| Cable for on-site CEE socket   | 1 m, 16 A              |                   |                 | 1 m, 16 A              |                 |                 |
| <b>Housing dimensions</b>  |                        | 400 × 500 × 200   | 355 × 400 × 200 |                        | 380 × 290 × 150 | 400 × 400 × 170 |

● = As standard ○ = With corresponding equipment possibly with additional control



**Extension PCB for controls:**  
BK 150 FUE-1 (E FU H), AK 500 FUE-1 (E FU H)

**Expansion card with 6 relays**

Air lock control, 6 additional switch outputs (1 × 4, 2 × 1 volt-free), 6 additional digital inputs

**Expansion card with 1 relay**

Air lock control, 1 additional switch output



**Induction loop evaluation unit**

1- or 2-channel plug-in print suitable for 2 separate induction loops, supplied without loop cable

# Accessories

For controls BK 150 FUE-1, AK 500 FUE-1, AK E and AK E light



**HS 4 BS**  
4 button functions,  
textured surface matt black



**Industrial hand transmitter HSI 6 BS, HSI 15 BS**  
To control up to 6 doors (HSI 6 BS) or 15 doors (HSI 15 BS), with extra-large buttons for easier operation with work gloves, impact-resistant housing  
Protection category IP 65



**External control element for FUE-1**  
For easy operation and programming, can be placed independent of the control, same control buttons as on the control, 4 × 7-segment display



**1-channel relay receiver HER 1 BS**  
1 volt-free relay output with status query



**2-channel relay receiver HET-E2 24 BS**  
2 volt-free relay outputs for choosing the direction, one 2-pin input for volt-free Open and Close limit switch reporting (for querying the door position)



Only from Hörmann

## Modern radio system

The bi-directional BiSecur radio system is based on future-oriented technology for the convenient and secure operation of industrial doors. The extremely secure BiSecur encryption protocol makes sure that no-one can copy your radio signal. It was tested and certified by security experts at Bochum university.

## Your advantages

- 128-bit encryption with the same high security level as online banking
- Interference-resistant radio signal with a stable range
- Convenient querying of the door position\*
- Backwards compatible, i.e. radio receivers with the frequency 868 MHz (2005 to June 2012) can also be operated with BiSecur control elements

\* For WA 300 S4 with optional bi-directional receiver ESEi BS, for all other operators with optional bi-directional receiver HET-E2 24 BS and end-of-travel position feedback



**Radar movement detector MWD-C**  
Fast and targeted automatic door opening,  
directional recognition, max. fitting height 7 m,  
fitting in cold store possible to max. -22 °C,  
IP 65



**Pull switch with plastic pull cord**  
Horizontal or vertical fitting possible,  
aluminium die-cast housing, IP 65,  
cord length 4 m



**Pull cord switch**  
With radio and batteryless transmitter,  
black plastic, IP 66



**Push button**  
2x "Open / Close" or  
3x "Open / Emergency-off /  
Close", plastic housing, IP 65



**Mushroom button**  
With large operating surface,  
plastic housing, IP 65



**Radar button HTR 1-24**  
Sensor for non-contact opening,  
plastic housing, IP 41



**Non-contact opening sensor**  
Plastic housing, IP 65



**Warning light**  
Ø 150 mm  
Red, plastic housing  
with mounting strap, IP 65



**Warning light**  
Ø 150 mm  
Red, green, plastic housing  
with fitting support, IP 65



**Rotating warning light**  
Red or yellow, plastic housing,  
IP 54



**Flashing warning light**  
Orange, plastic housing,  
IP 65

# Accessories

For controls BK 150 FUE-1, AK 500 FUE-1



## 3D laser scanner Scanprotect

Thanks to laser technology, the high-end motion detector and monitoring system guarantees operational safety, even with different floor coverings. The laser field acts as a reliable door monitor. It detects how fast and in which direction the object is travelling, ensuring optimum opening and closing reaction times. This minimises a door's hold time and saves energy.

- Especially suited for outdoor areas as it is not susceptible to different weather conditions **1**
- Reliable advance protection, as well as fast and targeted automatic door opening
- **NEW.** Energy savings thanks to automatic opening height adjustment depending on the detected vehicle height in the detection zone (only in conjunction with FUE-1 control) **2**
- Minimises the hold time of the door to save energy **3**
- Convenient setting options via the operator control
- Easy to hide objects permanently or temporarily in the detection range **4**
- Deactivation of cross-traffic and pedestrian traffic **5**
- Virtual pull switch enables door opening by people or vehicles standing at a defined position
- Visible LED spots on the floor assist during setup
- Easy connection to the operator control with plug-in wiring
- Bluetooth module for convenient configuration via app, e.g. with visualisation of the set field sizes in real-time



# Accessories

For controls

AK E 700 M, AK E 2500 M-I, AK E 750 M, AK E 370 M-I, AK E 370 M, BK 370 M FUE-1

---



**4-button hand transmitter**  
Black



**Pull switch with cord**  
Horizontal or vertical fitting possible,  
aluminium die-cast housing IP 65,  
cord length 4 m



**Radio receiver**  
For control via hand transmitter



**Push button**  
3x "Open / Emergency-off / Close",  
plastic housing, IP 65



**Push button**  
2x "Open / Close",  
plastic housing, IP 65



**Mushroom button**  
With large operating surface,  
plastic housing, IP 65



**Induction loop**  
Induction loop detector with normally open  
contact and change-over contact, can be  
set to pulse or permanent contact, direction  
recognition, 50 m loop cable



**Radar sensor**  
Fast and targeted automatic door opening,  
directional recognition, IP 65



**Rotating warning light**  
Red or yellow,  
plastic housing, IP 54

# Everything from a single source for construction and industry

Our large product range offers the right solution for any requirement. All products are optimally adjusted to work together, ensuring high functional safety. This makes us a strong, future-oriented partner for industrial and public construction projects.

**INDUSTRIAL DOORS. LOADING TECHNOLOGY. SLIDING DOORS.  
CONSTRUCTION PROJECT DOORS. PERIMETER PROTECTION SYSTEMS.**



Some of the products shown are equipped with special equipment and do not always correspond to the standard versions. The surface finishes and colours shown are subject to the limitations of the printing process and cannot be regarded as binding. All rights reserved. No part may be reproduced without our prior permission. Subject to changes.